

QUALITY RELOADING TOOLS

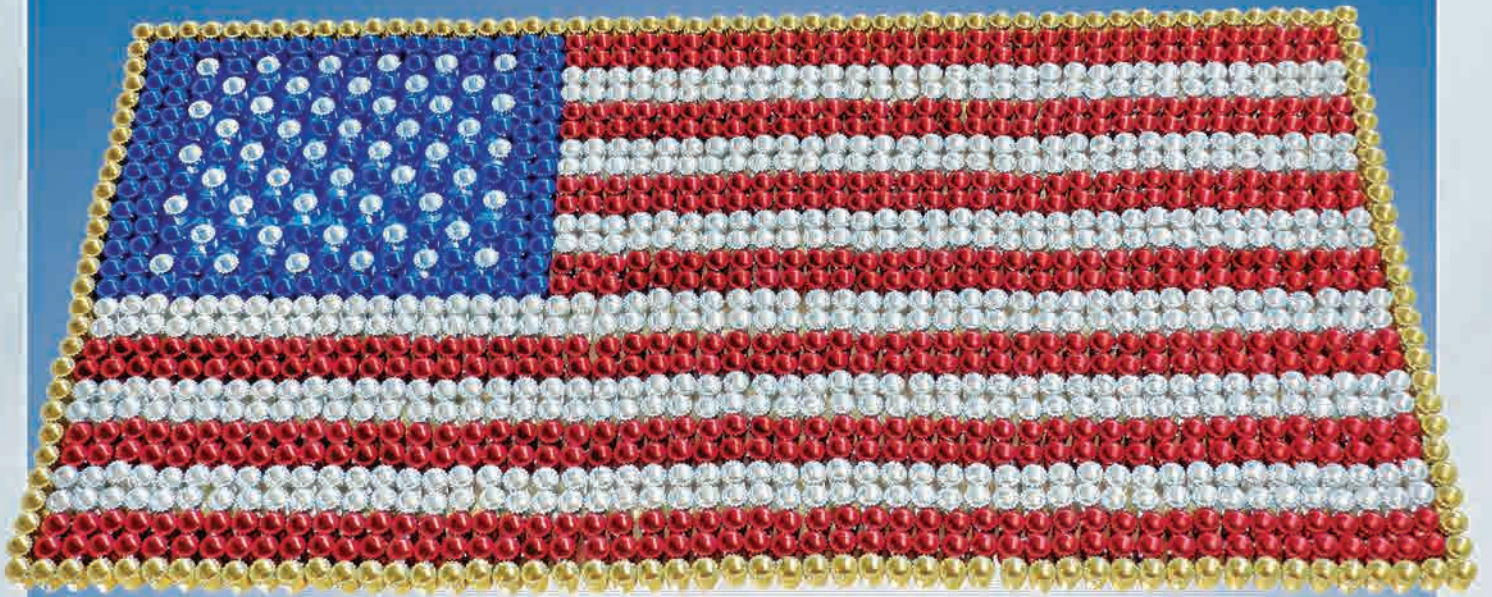

American Flag assembled with 1,184 Lee Spline Drive Bushings

PROUDLY MADE
★ **IN** ★
THE USA

LEE

LEE PRECISION, INC.

www.leeprecision.com

2-3	Lee Loader Reloading Basics
4	Reloading Stand Bench Plate
5	Modern Reloading II
6-7	Pistol Reloading Dies Carbide Factory Crimp Dies
8	Pistol Dies Size Chart
9	Spline Drive Lock Rings Shellholders
10	Rifle Die Selection
11	Rifle Factory Cimp Dies
12-13	Rifle PaceSetter Dies Rifle Collet Ultimate Die Sets
14-15	Rifle Dies Size Chart
16-17	Reloading Press Overview Single Stage and Progressive
18	Breech Lock Reloader Breech Lock Hand Press & Kit Ram Prime Breech Lock Ram Prime
19	Breech Lock Challenger Press 50th Anniversary Kit Breech Lock Challenger Kit Bench Prime Press Kit
20	Classic Cast Press 50 BMG Press Kit
21	Classic Turret Press and Kit
22	Value Turret Press and Kit
23	Progressive Press Accessories
24	Pro 1000 Pro 4000
25	Pro 4000 Load-Master
26	The APP Automatic Processing Press
27	The APP Accessories
28	Quick Trim Dies Case Trim Tools
29	Quick Trim & Case Length Gauge Charts Bulge Buster Kit
30	ACP Automatic Processing Press
31	Auto Bench Prime Auto-Prime Priming Tool Kits Shellholders
32	Deluxe Perfect Powder Measure Perfect Powder Measure Safety Scale Powder Funnel Powder Measure Kit
33	Pro Auto Disk Powder Measure Auto Drum Powder Measure
34	Electric Melters
35	Lubrication and Sizing
36	Rifle Bullet Molds
37	Pistol Bullet Molds
38	Black Powder Bullet Molds
39	Slug Molds Buckshot Molds Load-All II



*The kit that started it all,
The Classic Lee Loader*

* Calibers requiring considerable force for sizing.

Classic Lee Loader

More shooters have chosen the famous Lee Loader for their first reloading tool than any other. They realize it is all they need for good, accurate ammunition. In fact, at one time ammunition loaded with a Lee Loader held a world record listed in the Guinness Book of World Records for more than seven years. Millions upon millions of rounds have been reloaded with the famous Lee Loader. It's the perfect tool for those who wish to simply try reloading, because it will pay for itself in just an hour or two. Find out for yourself how much fun it is to reload with the Lee Loader. Everything you need to begin loading one caliber!

LEE LOADER 45.98

SIZING TYPE	LEE LOADER SIZES	
	223 Remington	90232
	243 Winchester	90235
	270 Winchester	90240
	7.62x54 Russian	90243
NECK SIZE	30/30 Win (30 Rem.)	90244
	308 Winchester	90245
	30/06 Springfield	90248
	303 British	90247
	45/70 Government	90264
FULL LENGTH	9mm Luger	90254
	38 Special	90257
NECK SIZE	357 Magnum	90258
	*44 Magnum	90260
FULL LENGTH	*45 ACP	90262
NECK SIZE	*45 Colt	90263

RELOADING

HANDGUN



Pistol Sizing Die

SIZE

REMOVING spent primer and RESIZING case can be accomplished by using any reloading press



Breech Lock Challenger Press
pg 19

PRIME

INSTALL PRIMER

Can be done on press or by hand



On press:
Prime with
Lever Prime System
pg 19

Hand Prime with New Auto-Prime

pg 31



Priming with Lee Auto-Bench Prime

pg 31



Press Priming with the Lee ACP Automatic Case Primer

pg 30



FULL LENGTH

OR

COLLET NECK

TRIM

RIFLE

NOTICE how the case neck is sized as case is withdrawn from die over the expander

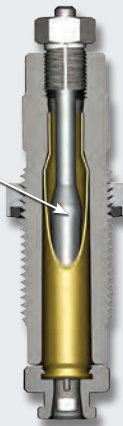

Rifle Full Length Sizing Die
LUBRICATE an inspected, clean case.



Rifle Collet Necksizing Die
No lube required. Cases must be fired through your gun only.

FOR SAFETY SAKE

CHECK CASES for proper trim length. Chamfer inside case neck to allow easy bullet installation.

Case Conditioning Kit
pgs 28- 29



Deluxe Quick Trim, trim and chamfer simultaneously
pg 28-29

RELOADING IS AN ENJOYABLE HOBBY, saves you money — and no manufacturer saves you more than Lee Precision, Inc. **Our mission is simple: produce the best American made value in reloading tools.** Our great prices come from patented, innovative designs. We are thankful to say that Lee Precision products are cast, machined and assembled in the USA.

A reloading press and a set of Lee Dies are all you need to start reloading. Lee Dies come complete with powder dipper, shell holder and instructions, along with comprehensive load data that tells

you how much and what type of powder to use. Dies and presses last a lifetime, so buying what your budget allows makes the most sense. For those with a workbench, consider our Lee Bench Plate for the ultimate convenience in mounting your presses. If you don't have a workbench, consider the Lee Reloading Stand, compact and very sturdy. If you have no loading equipment and are just getting started, you must consider that these basic steps need to be taken below.

Check out our complete line of reloading and casting equipment on our website, then visit your local merchant. If not blessed with a local dealer, one of the many online dealers will quickly and economically fill your order.

S E Q U E N C E

CHARGE

EXPAND CASE MOUTH AND CHARGE POWDER.
Lee handgun dies are unique in that you can charge powder during this operation



HANDGUN Powder Through Expanding Die



Auto Drum Powder Measure pg 33

SEAT & CRIMP

HANDGUN Bullet Seating Die



SEAT AND CRIMP THE BULLET

OPTIONAL

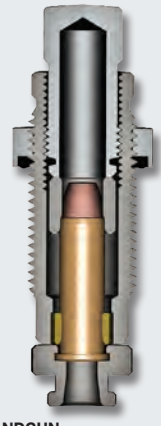

HANDGUN Carbide Factory Crimp Die
Easy to adjust crimp and carbide ring post sizes the case. pg 7

CHARGE

CHARGE POWDER
Powder Funnel and Dippers pg 32



Deluxe Perfect Powder Measure pg 32



SEAT

RIFLE Easy Adjust Dead Length Bullet Seating Die



SEAT THE BULLET

CRIMP

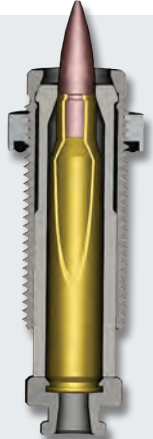

FACTORY CRIMP DIE
In most circumstances will improve velocity, uniformity and in all cases, factory-like utility & dependability. pg 11

Lee Reloading Stand

At last, a reloading stand built just for your reloading needs. The sturdy powder coated steel stand places your press at the perfect counter stool or standing height. Three-leg design assures absolute stability regardless of the floor condition. Rubber tipped legs suitable for any surface.

The thick steel top is fitted with the patented, quick change Lee Bench Plate System with steel base block to fit all Lee metallic presses.

The stand also includes a sturdy steel shelf with two bench plate receivers that will neatly and securely store your extra presses or mountable accessories. Each leg has eight mounting holes that allow you to accessorize your stand with a multitude of bins, shelves or accessory racks.

Dimensions 39" high x 26" wide x 24" deep

90688 190.00



CONCRETE BLOCK NOT INCLUDED

ACCESSORIES



Die Rack

Sturdy steel rack with fasteners designed for the Lee Reloading stand. Conveniently holds your dies at the ready, especially helpful when loading small batches of ammo with frequent die changes. Can also be wall or bench mounted.

90680 15.00



Bin and Bracket

Sturdy steel bracket and parts bin. Includes fasteners to allow direct mounting to the Lee Reloading stand, or workbench. Perfect for holding bullets, cases and loaded rounds.

90687 14.00



Steel Base Block

Rigid, powder coated steel construction. First choice for mounting all current Lee Presses. Works with the Lee Reloading Stand and Bench Plate. Fasteners for mounting one Lee reloading press are included.

90267 16.00

JUST REMOVE

AND REPLACE

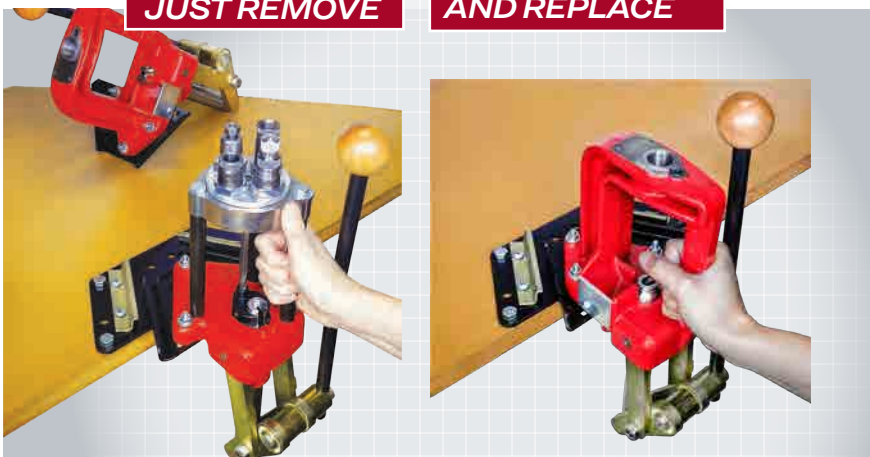

Patented design allows instant press change. So sturdy you can resize the monster 50 BMG case, then quickly switch to a smaller press for priming or other operations. Trapezoidal base block slides into perfect register and made immovable with the quick tightening of four bolts.

LEE BENCH PLATE



Includes steel base block with holes to mount any Lee press. Powder coated, thick steel plate mounts quickly and securely to any bench or tabletop. Wide steel plate distributes load, adding rigidity to the lightest bench top.

Lee Bench Plate 90251 36.00

UPDATED 2021

MODERN RELOADING SECOND EDITION BY RICHARD LEE

LEARN TO RELOAD AMMUNITION THAT'S MORE ACCURATE THAN FACTORY NEW ON YOUR FIRST TRY

THE SECOND EDITION OF MODERN RELOADING IS A SUMMARY OF A LIFETIME OF EXPERIENCE. NO MATTER HOW KNOWLEDGEABLE YOU ARE, YOU WILL FIND NEW AND INTERESTING INFORMATION IN THIS BOOK. IT IS A REFERENCE BOOK YOU WILL KEEP FOREVER.

OVER 38,000 LOADS covering over 170 cartridges in a new, larger, easier to read format, with velocities for starting loads. This is the best kind of load data — it is supplied by the powder companies.

LOAD DATA SORTED by velocity descending order.

DIPPER, AUTO DISK DATA included for easy setup.

NEW, LARGER, EASIER TO READ FORMAT with computer rendered and dimensioned drawings. Cartridges tabbed for quick reference.

LATEST INFORMATION ON PRESSURE

EXCLUSIVE PRESSURE AND VELOCITY FACTORS enable you to accurately calculate pressure and velocity for reduced loads. An absolute necessity for cast bullet shooting.

A NEVER BEFORE PUBLISHED in depth analyses of current load data. It gives you insight into the effects of reducing or increasing a charge.

MODERN RELOADING SECOND EDITION 90277 30.98

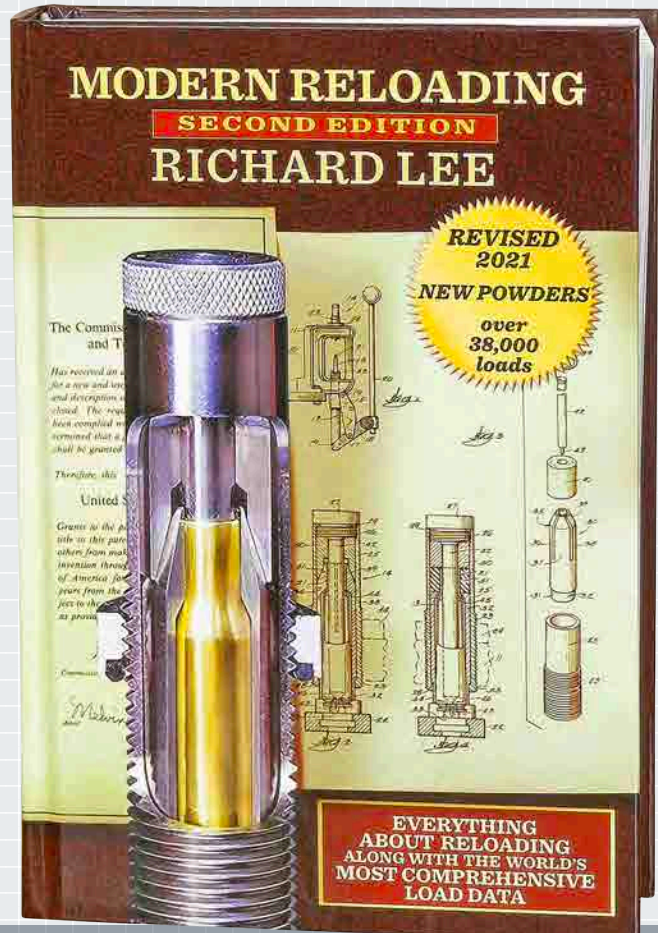

Contains everything about reloading, with the world's most comprehensive load data, over 38,000 loads

7MM REMINGTON MAGNUM section with technical diagrams and a table of load data.

Auto Bench Prime section with an image of the primer and text describing its use.

7MM REMINGTON MAGNUM section with a detailed table of load data for various cartridges.

POWDER BURNING RATE CHART and CHAPTER 10 section with a table of powder data.

SELECTING THE BEST HANDGUN DIE SET

Lee handgun dies feature a carbide sizing die — simply the best way to resize straight walled handgun cartridges.

Select the **DELUXE PISTOL 4-DIE SET** when using mixed range brass. The Deluxe Set includes the Carbide Factory crimp die. This die allows you to separate bullet seating from the crimping operation. It makes setup much easier and the die has the added feature of a carbide resizer that does a finishing sizing pass on the completed round. This final sizing guarantees that any case that passes through the die will freely and reliably chamber in any gun. The **CARBIDE & STEEL THREE DIE SETS** work fine when using a quality controlled source of brass, like cases fired only in your gun. More care is required when adjusting the bullet seat and crimp die, as seating and crimping occur simultaneously. Bullet diameter control is important when not using the factory crimp.

Lee Dies reload cartridges better, easier, more accurately and with fewer problems!

Pre-adjust and color code your dies with spline drive bushings

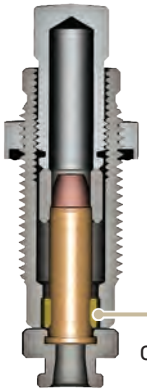

CARBIDE FACTORY CRIMP DIE

Carbide ring in base resizes any portion of case that exceeds factory new dimensions. Floating crimp ring is finger adjustable to provide the perfect crimp.

HARDENED STEEL SHELLHOLDER

Others charge \$15.00 for this item!

Exclusive feature to Lee POWDER MEASURE & CHARGE TABLE



Exclusive feature to Lee POWDER THROUGH EXPANDING DIE

Only Lee Dies permit charging the case while expanding the case mouth. Every Lee Pistol Die Set includes this Powder Through Expanding Die at no extra cost. The powder funnel adapter can be replaced with a Lee case actuated Powder Measure (pg. 33) for fully automatic powder charging while the case mouth is being expanded.

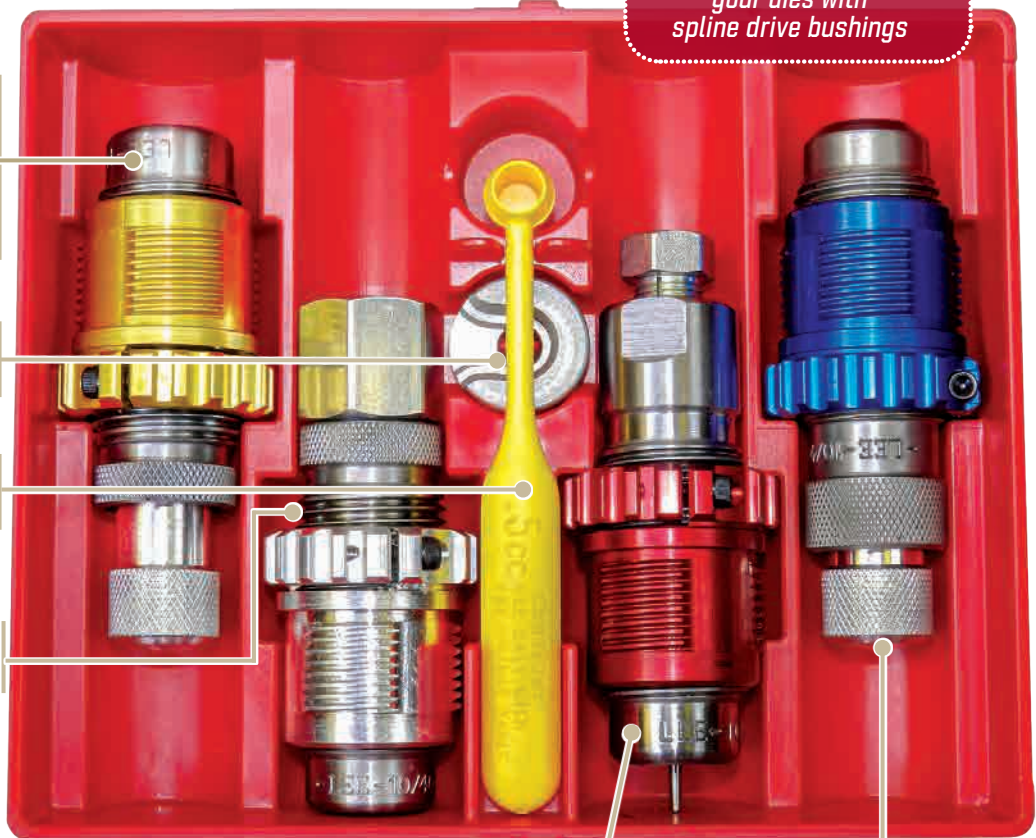

RELOADING DIES shown with COLOR CODED SPLINE DRIVE BUSHINGS installed. See page 8

CONTOUR GROUND CARBIDE SIZING DIE

BULLET SEAT & FEED DIE

Carbide Sizer

All Lee straight walled pistol dies have tungsten carbide sizer rings. Carbide is so hard that it can only be ground and polished with diamond wheels. This hard diamond polished surface eliminates the need for case lubrication—they will never wear out. Exclusive contour grind sizes closer to the rim than any other brand. The collet held decapper is nearly unbreakable even if you misadjust it or deprime crimped military cases. The decapper clamp accurately centers the decapper in the die. Should you over stress it for any reason, it harmlessly slides up without breaking. Easily reset with no limit to the amount of times it can be reset.



Bullet Seat and Feed Die

Universal free floating seating plug works with nearly any point style bullet. No need to change seater plugs for different nose types. Finger adjustable seating depth eliminates fumbling with pliers, lock nuts and screwdrivers to make simple seating depth adjustment. Die is tapered on end for use with automatic bullet feeders.



LEE exclusive feature

ONLY LEE DIES COME COMPLETE WITH POWDER MEASURE and CHARGE TABLE

PISTOL DIE SETS

LEE DELUXE PISTOL 4-DIE SET 77.00

INCLUDES CARBIDE FULL LENGTH SIZING DIE, POWDER THROUGH EXPANDING DIE, BULLET SEAT AND FEED DIE AND CARBIDE FACTORY CRIMP DIE.

Combines the world's most popular carbide three-die set with the Lee Carbide Factory Crimp Die at a great price. No other die set at any price produces more reliable or accurate ammo.

By separating the seating and crimping operation, you will benefit by greatly simplified adjustment. More importantly, the Carbide Factory Crimp Die post sizes your case, assuring that any round that passes through the die will chamber properly in your gun. This, plus all the other exclusive features — make this the best die set money can buy!

LEE CARBIDE PISTOL 3-DIE SET 55.98

INCLUDES CARBIDE FULL LENGTH SIZING DIE, POWDER THROUGH EXPANDING DIE AND BULLET SEAT AND FEED DIE.

We use a solid carbide insert, ground to a special contour that does not leave the objectional belt mark on the case, common to ordinary carbide dies. With a carbide sizer, no case lube is needed, and you don't even have to clean your cases.

NO NEED FOR A TAPER CRIMP DIE; BETTER ACCURACY WITH LEE DIES.

Taper crimp dies are used to correct the problems caused by the improper expanding plug design or adjustment. They distort the bullet shank and reduce accuracy. Because the Lee Expander flares the minimum amount, consistent with easy bullet insertion, all of the flare is removed with the bullet seating die, thus eliminating the need for a taper crimp die.

LEE STEEL PISTOL 3-DIE SET 55.98

INCLUDES STEEL FULL LENGTH SIZING DIE, POWDER THROUGH EXPANDING DIE, BULLET SEAT AND FEED DIE, AND RESIZING LUBRICANT PACKET

Same features as our premium carbide sets, except the case must be lubricated.

STORAGE IS EASY

LEE DIES ARE PACKED IN A FITTED BOX THAT ALLOWS DIES TO BE RETURNED TO THE BOX ADJUSTED WITH OR WITHOUT THE LEE BREECH LOCK BUSHING OR SPLINE DRIVE BUSHING INSTALLED

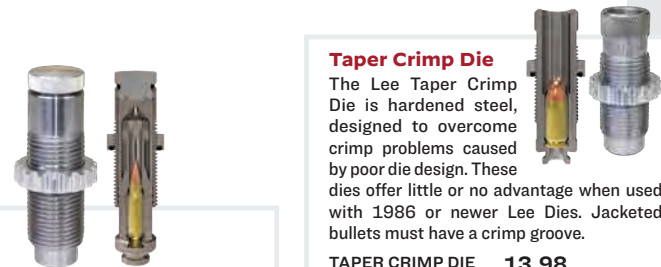

Short Bottle Neck Collet Style Factory Crimp Die

Incorporates a collet to apply a rifle type crimp to the case. Makes these very difficult to crimp cartridges a delight to reload. Bullets do not need a crimp groove, as the collet is so powerful it will form one.

BOTTLE NECK PISTOL FACTORY CRIMP DIE

25.00

Taper Crimp Die

The Lee Taper Crimp Die is hardened steel, designed to overcome crimp problems caused by poor die design. These dies offer little or no advantage when used with 1986 or newer Lee Dies. Jacketed bullets must have a crimp groove.

TAPER CRIMP DIE 13.98

Collet Style Factory Crimp Die

Popular with cast bullet shooters that wish to use oversize bullets; also very popular when reloading heavy recoiling revolvers. No other crimping system can apply as secure a crimp at the Lee Collet style Factory Crimp Die. No crimping groove required in jacketed or cast bullets, this die is so powerful it forms a crimp groove if one is not present.

COLLET STYLE CRIMP DIE 15.98

CARBIDE FACTORY CRIMP DIE

Lee Carbide Factory Crimp Die

A CARBIDE SIZER SIZES THE cartridge while being crimped, so every round will positively chamber freely with factory like dependability. The adjusting screw quickly and easily sets the desired amount of crimp. It

is impossible to buckle the case as with a conventional bullet seating die. Trim length is not critical so this extra operation takes less time than it would if cases were trimmed and chamfered.

Revolver dies roll crimp with no limit as to the amount. A perfect taper crimp is applied to auto-loader rounds. The crimper cannot be misadjusted to make a case mouth too small to properly head-space. A firm crimp is essential for dependable and accurate ammunition—it eliminates the problems of poor ignition of slow burning magnum powders.

CARBIDE FACTORY CRIMP DIE 28.98



INCLUDED WITH DELUXE 4-DIE SETS

FOR HANDGUN AMMUNITION THAT MUST WORK

	CRIMP STYLE	CARBIDE FACTORY CRIMP DIE	SHORT BOTTLE NECK COLLET STYLE FACTORY CRIMP DIE	COLLET STYLE FACTORY CRIMP DIE	TAPER CRIMP DIE
5.7x28 FN		N/A	90725	N/A	N/A
22 TCM		N/A	90087	N/A	N/A
30 M1 Carbine · 32/20		N/A	N/A	90421	N/A
30 Luger		N/A	90175	N/A	N/A
30 Tokarev & 30 Mauser		N/A	90086	N/A	N/A
32 ACP · 32 S&W Long 32 H&R Mag · 327 Federal	ROLL	90067	N/A	N/A	N/A
9mm Makarov	TAPER	90807	N/A	N/A	N/A
9mm Luger	TAPER	90860	N/A	N/A	90780
357 Sig		N/A	90076	N/A	N/A
38 Super & 38 ACP	TAPER	90866	N/A	N/A	90780
380 Auto	TAPER	90867	N/A	N/A	90780
38 Special	ROLL	90861	N/A	N/A	90781
357 Magnum	ROLL	90861	N/A	90813	90781
40 S&W & 10mm Auto	TAPER	90862	N/A	N/A	90782
41 Magnum	ROLL	90416	N/A	N/A	N/A
44 Special	ROLL	90863	N/A	N/A	90784
44 Magnum	ROLL	90863	N/A	90930	90784
44 Russian	ROLL	90863	N/A	N/A	N/A
45 Colt	ROLL	90865	N/A	90302	90786
45 ACP · 45 Auto Rim · 45 GAP · 45 Win Mag	TAPER	90864	N/A	N/A	90785
400 CorBon		N/A	90173	N/A	N/A
455 Web Mark II		N/A	N/A	N/A	90785
454 Casull	ROLL	90865	N/A	N/A	90786
460 S&W		N/A	N/A	90926	N/A
500 S&W		N/A	N/A	90931	N/A

FREE SHELLHOLDER

included where shown

The price of Lee Dies include a FREE SHELL HOLDER of the proper size. Some manufacturers charge \$15.00 extra for this necessary part.



DELUXE PISTOL 4-DIE SET | P 7

CARBIDE 3-DIE SET | P 7

STEEL 3-DIE SET | P 7

SIZING DIE ONLY

POWDER THROUGH EXPANDING DIE

TAPER CRIMP DIE | P 7

FACTORY CRIMP DIE | P 7

COLLET STYLE CRIMP DIE | P 7

CASE LENGTH GAUGE | P 29

UNIVERSAL SHELLHOLDER | P 9

PRIMING TOOL SHELLHOLDER | P 31

QUICK TRIM DIE BODY | P 28

	77.00	55.98	55.98	29.98	14.98	13.98	20.00-28.98	15.98	8.00-13.00	5.98	3.98	16.00-20.00
22 TCM [2-Die Set]			90803	91032	N/A		90087			90521	90204	91373
5.7 x 28 [2-Die Set]			90603	91129	N/A		90725		90219	90002	90017	91363
25 ACP		90568		91204	91141					90002	90017	
30 M1 Carbine		90626♦		90617♦	90494			90421	90135	90524	90207	90365
30 Luger			90754	91212	91142		90175			90004	90023	
30 Mauser			90755	91213	91142		90086			90004	90023	
7.62 Tokarev			90769	91214	91142		90086		91336	90004	90023	
32 ACP		90622		90621	91144		90067		91338	90524	90207	
32 S & W		90696		90621	91144				91311	90521	90204	
32 S & W Long		90624		90621	90490		90067		90169	90521	90204	
32 H & R Mag / 327 Federal		90809		90621	90490		90067		91310 91303	90521	90204	
32/20			90751	91221	91145			90421	90146	90523	90206	
38/40			90761	91215	91146			90852		90001	90272	
9mm Makarov		90176		91206	91147		90807		90684	90004	90023	90181
9mm Luger	90963	90509		90548	90580	90780	90860		90153	90004	90023	90032
357 Sig			90270	91216	91148		90076		91317	90004	90023	
38 Short / Long Colt		90276		91207	91149				91321	90518	90201	
38 Super / 38 ACP		90623		90619	91168	90780	90866		90217	90004	90023	
380 Auto	90447	90625		90618	90492	90780	90867		90155	90521	90204	90025
38 S & W		90569		90619	91149				90156	90518	90201	
38 Special / 357 Magnum	90964▼	90510		90530	90581	90781	90861		90157 90158	90518	90201	90085 90088
40 S & W / 10mm Auto	90965▼	90799		91208	90620	90782	90862		90154 90127	90004	90023	90033 90193
41 Mag		90628		91220	91169		90416		90159	90526	90209	90226
429 Desert Eagle			90796	91504	91171				90528	90211		
44 Special / 44 Magnum	90966▼	90516		90531	90583	90784	90863		90160 90161	90528	90211	90107 90125
44 Russian		90293		90531	91152		90863			90528	90211	
44/40			90564	91217	91153			90854	90168	90001	90272	
45 Colt	90967#	90514**		90533	90586	90786	90865	90302	90163	90528	90211	90145
45 ACP	90968	90513		90532	90585	90785	90864		90162	90519	90202	90073
45 Auto Rim		90808		90532	90585	90785	90864			90199	90213	
45 Schofield		90323		90533	91154	90785				90001	90272	
400 Cor Bon			90430*	91218	91155		90173			90519	90202	
455 Web Mark II		90764		90533	91156	90785				90522	90205	
45 Win Mag		90810		90532	90585	90785	90864			90520	90203	
454 Casull		90795		90533	90586	90786	90865		90992	90528	90211	90174
45 Gap		90498		90532	91156		90864		91473	90519	90202	
460 S & W		90344		91209	91157			90926	90220	90001	90272	
480 Ruger		90499		91210	91158		91242		90018	90522	90205	
50 Action Express			90329	91219	91159				91327	90528	90211	
500 S&W Mag		90288		91211	91159			90931	90019	90003	90200	90178

HAVE A BREECH LOCK PRESS?

Breech lock bushings fit all Lee Breech Lock presses. Allows instant, accurate die changes.

Breech Lock Bushings



90600 2-Pk 12.98
Perfect with Lee Lock Rings



Spline Drive Bushings

Breech lock quick change bushing with integral lock collar provides unmatched precision and convenience when adjusting dies. Split clamp positively locks die into position.

90063 2-Pk 16.00

Buy more for greater savings



90042 3-Pk 21.00



90095 4-Pk 26.00

COLOR CODED FOR QUICK, POSITIVE DIE SELECTION

▣ Can be used to load magnum cases ▣ Can be used to load maximum cases ▼ Includes load data for magnum cases # can be used to load the 475 Linebaugh # can be used to load the 454 Casull
*These dies do not include load data ♦ 30 M-1 Carbine \$14.00 extra
S/O Special Order Factory Direct

LEE ULTIMATE SPLINE DRIVE LOCK RINGS

are the perfect choice when using older style presses that require screwing your dies in and out for every operation. The new split clamp spline drive makes all other lock rings obsolete and clumsy to use.

The socket head cross bolt, even when lightly tightened, applies a vise-like grip on your dies. No tiny set screws that easily strip or damage your die threads.

We added the famous Lee "O" ring because, no matter how securely you have the lock ring clamped to the die, it will loosen in the press frame during operation without the friction of the "O" ring. The "O" ring allows you to finger tighten into your press and will never loosen during operation. Kit includes a wrench for easy die removal.

ULTIMATE LOCK RINGS

90566 3 pack with wrench 12.98

91640 4 pack color coded. Lock ring wrench sold separately 16.98

LOCK RING WRENCH

90093 3.98

A handy, compact wrench makes the new lock rings a delight to use. Spline drive lock rings are now standard equipment on all Lee dies. Update older Lee Dies or competitor's dies.

SPLINE DRIVE LOCK RINGS (3-PACK)

90534 Lock ring wrench sold separately 5.98

NOW STANDARD ON ALL LEE DIES. These lock rings are perfect for presses equipped with Quick change die bushings or removeable die heads found on most progressive and our turret presses. Smallest

outside diameter lock rings available. Captive friction "O" ring provides immovable die position with just finger tightening. Handy, no tool required die adjustment.

WORKS ON TIGHT TOOLHEADS



BIG GUN INSPIRED BREECH LOCK QUICK CHANGE STANDARD ON ALL LEE SINGLE STATION PRESSES

Switch dies with a 3/8 of a turn rather than fourteen or more turns. Loading with a breech lock equipped press is as convenient as a Turret Press when loading small quantities of ammunition. Interrupted three-start thread assures dies will return and lock into the exact same position. If cost is more important than convenience, you can leave the Breech Lock bushing locked in the press and screw dies in and out like a conventional press.

Spline Drive Bushings

Breech lock quick change bushing with integral lock collar provides unmatched precision and convenience when adjusting dies. Split clamp positively locks die into position.

90063 2-Pk 16.00

Buy more for greater savings

90042 3-Pk 21.00

90095 4-Pk 26.00

Color coded for quick, positive die selection



Change dies instantly with a twist of the wrist

Breech Lock Bushings

Breech lock bushings fit all Lee Breech Lock presses. Allows instant, accurate die changes.

90600 2-Pk 12.98



Decapping Die

An absolute must for those who clean cases before reloading. No cleaning or lubing needed when using this die. Tough, almost unbreakable decapper easily removes crimped in primers. Fits cases up to .560" in diameter; up to 3.125" long.

90292 15.98

REPLACEMENT DECAPPER
UNGUIDED 90783 2.50
GUIDED 4.00

For smooth operation and less decapper bending or breaking, order caliber specific guided decapper.

91574	17 CAL-204 RUGER	91580	30 CAL
91576	22 CAL	91581	34-35 CAL
91577	6mm-25 CAL	91583	40 CAL
91578	27 CAL -7mm	91584	45 CAL



Universal Case Expanding Die

Gently flares the case mouth to accept cast bullets without shaving. Works great to prevent damaging the moly and low friction coatings found on today's high performance jacketed bullets. Includes neck plugs for .22 cal through .45 cal. Works on everything from the 22 Hornet to the largest Ultra Mag. Costs so little and works so well you can't afford to be without one.

90798 18.00

Utilize all your brass by removing annoying bulge rings

BULGE BUSTER KIT shown mounted to Breech Lock Reloader Press (90045). Sold separately, pg.18



Lee Bulge Buster Kit

Assure your mixed brass is bulge free with the Bulge Buster Kit and appropriate Lee Carbide Factory Crimp Die. This push through die adapter will quickly remove the annoying bulge rings that shell holder constrained dies simply can't reach. The Bulge Buster Kit includes extension sleeve, push through punch, catch container and complete instructions. And it's fast - you can reprocess your cases as quickly as you can handle them. CARBIDE FACTORY CRIMP DIE, SEE PAGE 7

Bulge Buster Kit 90487 19.98

WITH THE LEE FACTORY CRIMP DIE, THE BULGE BUSTER WILL REPAIR ALL THESE RIMLESS CASES

90867	380 ACP	90864	45 ACP
90862	10 mm	90864	45 GAP
90862	40 S&W	90864	45 Win Mag
90416	41 AE		



Push through Punch Extension Sleeve Catch Container

SHELL HOLDER	FOR PRESSES 5.98	HOLDER	PISTOL
#1	90518	15	5.7 x 28
#2	90519	1	22 Rem. Jet
#3	90520	15	25 ACP
#4	90521	1	256 Win. Magnum
#5	90522	19	30 Luger
#6	90523	19	30 Mauser
#7	90524	4	32 Short Colt
#8	90525	4	32 Long Colt
#9	90526	4	32 S & W
#10	90527	4	32 S & W Long
#11	90528	7	32 ACP
#12	90529	4	32 Colt N.P.
#13	90199	4	380 Auto
#14	90001	19	9mm LUGER
#15	90002	1	38 S & W
#16	90003	1	38 Colt N.P.
#17	91497	19	38 Super Auto
#18	91498	19	38 ACP
#19	90004	1	38 Short Colt
#20	91499	1	38 Long Colt
#21	90599	1	38 Special · 357 Mag
#22	91500	19	357 Sig
#23	91501	2	357 Auto Magnum
#24	91502	19	40 S&W · 10mm Auto
#25	91503	1	41 Long Colt
		19	41 Action Express
		9	41 Magnum
		11	44 S&W Spl · 44 Mag
		11	44 S & W Russian
		2	44 Auto Mag.
		2	45 Auto
		2	45 Colt
		11	45 Casull
		14	460 S&W
		5	455 Webley
		13	45 Auto Rim
		3	45 Win. Magnum
		5&16	480 Ruger
		5	475 Linebaugh
		16	500 S&W

Additional cartridges listed on www.leeprecision.com



1 · 2 · 3 · 4 · 5 · 7 · 8
9 · 10 · 11 · 19

SET OF SHELLHOLDERS

Eleven of the most popular sizes fit over 115 different cartridges. The chart (left) is included with each shell holder set.

UNIVERSAL SHELL HOLDER SET 90197 47.00

WORKS WITH ALL BRANDS OF PRESSES

NOT PURCHASING LEE DIES?

YOU'LL STILL NEED A SHELL HOLDER ONLY LEE OFFERS A **FREE SHELL HOLDER** WITH EVERY PISTOL DIE SET PURCHASE

[OTHERS CHARGE \$14.50 FOR THIS NECESSARY PART!]

Lee Die Boxes

Perfect storage for dies. Made from tough, durable plastic.

SINGLE DIE BOX	90616	2.98
ROUND DIE BOX	90535	7.50
FLAT 3-DIE BOX	90791	4.98
FLAT 4-DIE BOX	90422	5.98

Holds dies with Breech Lock Quick Change insert installed.

Round Die Box lets you store dies installed in 3-hole turret.



LEE OFFERS THE MOST COMPLETE DIE SETS



FREE SHELL HOLDER
SOME CHARGE OVER \$15.00 FOR THIS NECESSARY PART

FREE COMPREHENSIVE LOAD DATA
PRICELESS ON SOME CARTRIDGES

FREE POWDER DIPPER

EASIEST TO ADJUST DIES
WITH FINGER TIGHTEN LOCK RINGS

BUILT-IN STUCK CASE REMOVER

CASE SIZING LUBRICANT
INCLUDED WITH PACESETTER & ULTIMATE DIE SETS

TIGHTEST TOLERANCE IN THE INDUSTRY

EXCLUSIVE FEATURE
PACESETTER AND ULTIMATE DIE SETS
INCLUDE FACTORY CRIMP DIE;
THIS DIE FIRMLY CRIMPS BULLET IN PLACE
AND APPLIES A FACTORY-STYLE CRIMP



**NO TOOL
REQUIRED
FINGER
ADJUSTABLE
BULLET SEATING**



**BUILT-IN
STUCK CASE REMOVER**
CASE SIZING LUBRICANT

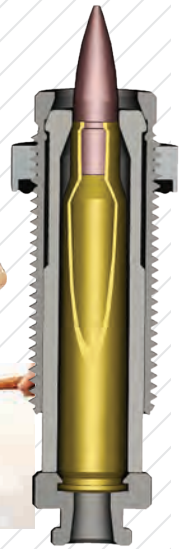

**EXCLUSIVE
FACTORY
CRIMP DIE**

Lee Pacesetter & RGB Series Dies

FOR PRODUCING
FACTORY-DIMENSIONED
AMMO THAT RELIABLY
FITS AND FEEDS
IN ANY GUN



RGB DIES
see page 12

First choice for semi-auto actions. Full-length sizing is a must if you are reloading for more than one firearm or reloading cases that were fired in other firearms. Pacesetter 3-die sets include the LEE FACTORY CRIMP DIE.



PACESETTER DIES page 12

IF YOU INTEND TO RELOAD CASES FIRED IN OTHER GUNS
OR YOU ARE RELOADING FOR MORE THAN ONE GUN,
SELECT THE

Lee Ultimate Rifle Die Set

The Ultimate Set includes a full length resizing die that allows you to restore any case to factory original dimensions so that you can fire form in your gun and then reload using the superior Collet neck sizing die. Ultimate Rifle Die Sets include the LEE FACTORY CRIMP DIE.



COLLET
NECKSIZING
DIES
see page 13

Lee Collet Necksizing Dies

For best accuracy, longest case life and no resizing lubricant required. Only the neck of the case is resized. The body is untouched—retains perfect fit to your gun's chamber. Cases should have been fired in your firearm only. Benchrest shooters' first choice; there is no other die that can produce a more accurate cartridge.



ULTIMATE RIFLE DIE SET see page 13

FACTORY CRIMP DIE



THE LEE FACTORY CRIMP DIE is the only effective way to crimp bottleneck rifle cartridges. Our Factory Crimp Die should be used on all loads used for hunting. Applying a factory crimp will always improve the utility of the cartridge, and in most cases, will also improve the accuracy.

The Lee Factory Crimp die crimps the bullet in place more firmly than any other tool. It is impossible to buckle the case as with regular roll crimp dies. Trim length is not critical. Tests demonstrate that even bullets which have no cannelure will shoot more accurately if crimped in place with the Lee Factory Crimp Die.

Factory ammunition is often more accurate and better able to withstand rough handling because the bullet is firmly crimped in place. A firm crimp improves accuracy because pressure must build to a higher level before the bullet begins to move. This higher start pressure insures a more uniform pressure curve and less velocity variation. Even powder selection is less critical. Until now, handloaders seated the bullet to touch the rifling to achieve similar results. This is not always possible nor desirable. The Lee Factory Crimp Die is included at no

extra charge with Lee PaceSetter 3-Die Sets and Ultimate Rifle Die Sets. It's just another added value that only Lee Dies offer.

LEE FACTORY CRIMP DIE 15.98

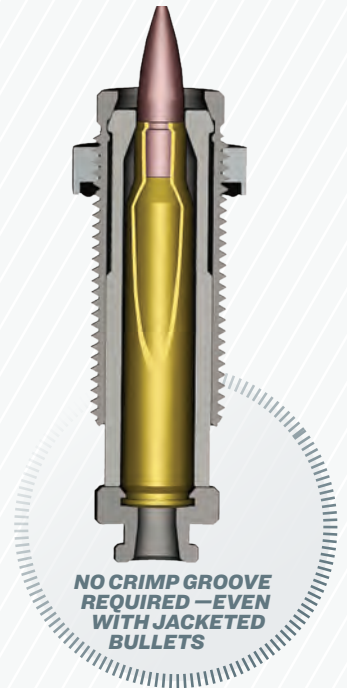

NOT PURCHASING LEE DIES? YOU'LL STILL NEED A SHELL HOLDER

MOST LEE RIFLE DIE SETS INCLUDE A **FREE SHELL HOLDER**. Others charge \$15.00 for this necessary part!

SET OF SHELLHOLDERS Eleven of the most popular sizes fit over 115 different cartridges. Chart below included with each shell holder set. Additional cartridge listings on our website.



UNIVERSAL SHELL HOLDER SET

90197 47.00

Works with all brands of presses

1 · 2 · 3 · 4 · 5 · 7 · 8 · 9 · 10 · 11 · 19

SHELL HOLDER	FOR PRESSES 5.98
#1	90518
#2	90519
#3	90520
#4	90521
#5	90522
#6	90523
#7	90524
#8	90525
#9	90526
#10	90527
#11	90528
#12	90529
#13	90199
#14	90001
#15	90002
#16	90003
#17	91497
#18	91498
#19	90004
#20	91499
#21	90599
#22	91500
#23	91501
#24	91502
#25	91503

HOLDER	RIFLE	HOLDER	RIFLE	HOLDER	RIFLE	HOLDER	RIFLE	HOLDER	PISTOL
20	17 Hornet	2	250 Savage	12	7.62mm x 39	2	35 Remington	7	32 ACP
4	17 Remington	3	25/35	16	7.62x54 Russian	5	35 Winchester	4	32 Colt N.P.
4	204 Ruger	4	25/45 Sharps	3	30 Herrett	2	35 Whelen	4	380 Auto
4	22 TCM	2	257 Roberts	3	30/30 Win. (30 WCF)	5	350 Rem. Mag.	19	9mm LUGER
20	22 Hornet	5	257 Weatherby	2	300 Savage	3	356 Winchester	1	38 S & W
20	22 K Hornet	2	6mm Creedmoor	16	30/378	2	358 Winchester	1	38 Colt N.P.
3	22 Savage	2	6.5mm Creedmoor	21	30 Remington	5	358 Norma Magnum	38	Colt Super Auto
2	22 BR	2	6.5mm 06	2	308 Win. (7.62 NATO)	3	375 Winchester	19	38 ACP
6	218 Bee	2	6.5mm x 57	4	300 AAC Blackout	5	375 H & H	19	38 ACP
12	22 PPC	3	6.5 x 55 Mauser	5	30/40 Krag (30 U.S.)	5	375 Weatherby	1	38 Short Colt
3	219 Zipper	10	6.5 Jap	2	30/06 Springfield	5	375 Ultra Magnum	1	38 Long Colt
10	220 Swift	5	6.5 Rem. Magnum	5	300 H & H	5	375 Ruger	1	38 Special - 357 Mag
4	221 Fireball	2	6.5 Carcano	5	300 Weatherby	14	38/40 Win.	19	357 Sig
4	222 Remington	12	6.5 Grendel	5	300 Win Magnum	3	38/55 Winchester	2	357 Auto Magnum
4	222 Rem. Magnum	5	264 Win. Magnum	5	300 Ultra Magnum	8	40/82 Winchester	19	40 S&W - 10mm Auto
4	223 (5.56mm)	5	26 Nosler	5	300 Win S Magnum	5	416 Remington	1	41 Long Colt
5	223 WSSM	21	6.8 SPC	5	308 Norma Magnum	25	416 Rigby	9	41 Action Express
2	224 Clark (22/257)	2	270 Winchester	5	303 British	18	43 Mauser	19	41 Magnum
21	224 Valkyrie	5	270 Weatherby	2	7.7 Japanese	17	43 Spanish	9	41 Magnum
10	225 Winchester	5	270 Win S Mag	3	32 Win. Spc'l	14	44/40	11	44 S&W Spl - 44 Mag
2	22/250	2	280 Remington	3	32 Win. S.L.	11	444 Marlin	11	44 S & W Russian
2	240 Weatherby	2	7mm/08	6	32/20 (32 W.C.F.)	8	45/70 Gov't	2	44 Auto Mag.
2	243 Win.	2	7mm BR	3	32/40 Winchester	2	450 Bushmaster	2	45 Auto
5	243 WSSM	4	7mm TCU	2	8 x 57 Mauser	5	458 Win. Magnum	11&14	45 Colt
2	6mm Remington	3	7 x 30 Waters	2	8mm 06			14	45 Schofield
2	244 Remington	2&10	7 x 57mm Mauser	2	8mm Man. Schoe.	15	5.7 x 28	11	454 Casull
2	6mm Int'l	5	7 x 61 Sharpe & Hart	5	8mm Rem. Magnum	1	22 Rem. Jet	14	460 S&W
2	6mm/284	5	7mm Rem. Magnum	17	8mm Lebel	15	25 ACP	5	455 Webley
2	6mm/284	5	7mm Win S Mag	16	8x56R Hungarian	1	256 Win. Magnum	13	45 Auto Rim
12	6 PPC	5	7mm Weatherby	8	33 Winchester	19	30 Luger	3	45 Win. Magnum
4	6 x 47 (6mm/222M)	5	7mm Ultra Mag	25	338 Lapua	19	30 Mauser	5&16	480 Ruger
2	25/284	2	284 Winchester	5	338 Win. Magnum	4	32 Short Colt	5	475 Linebaugh
5	25/303	3	7.5mm Schmidt-Rubin	5	338 Ultra Magnum	4	32 Long Colt	16	500 S&W
2	25/06	7	30 M 1 Carbine	5	340 Weatherby	4	32 S & W		
6	25/20 Winchester	3	7.65x53 Arg. Mauser	8	348 Win.	4	32 S & W Long		

BEST

INTERNAL FINISH IN THE INDUSTRY

ALL LEE DIES ARE MACHINE HONED TO THE SMOOTHEST POSSIBLE FINISH
 Don't confuse this with the surface polish that's used by most manufacturers. A polish simply makes a shiny surface. It's like trying to sand wood without backing under the sandpaper. The surface in Lee dies is progressively honed to a fine finish with no waves or ripples.

INCLUDES

- FULL LENGTH SIZING DIE
- BUILT IN STUCK CASE REMOVER
- RESIZING LUBRICANT PACKET
- EASY X EXPANDER
- EASY ADJUST DEAD LENGTH BULLET SEATING DIE
- FACTORY CRIMP DIE
- SHELL HOLDER
- POWDER DIPPER
- LOAD DATA & INSTRUCTIONS



LEE SAFETY POWDER SCALE 80663
 It is the easiest to use, most accurate and sensitive powder scale. Made exclusively to weigh gun powder. The Lee Safety Scale has magnetic dampening and an approach-to-weight lifter enclosed within its heavy metal base. The exclusive safety beam has a stainless steel razor edge for maximum sensitivity. You can be sure that the Lee Safety Scale will retain its original factory accuracy as long as it is not physically broken. Perfect for weighing charges!

INCLUDES THE EXCLUSIVE LEE FACTORY CRIMP DIE

Lee PaceSetter™ 3-Die Set

THESE DIES ARE YOUR BEST BUY!
 Lee PaceSetter 3-Die sets include the exclusive Lee Factory Crimp™ Die to produce factory-like ammunition with improved utility and accuracy. The die set also includes an easy adjust dead length bullet seater, shell holder, powder dipper, load data—and all are packed in the nicest storage box ever designed. The extras represent a \$32.00 value. Most are unavailable at any price from other suppliers.

These are the most copied dies in the world. Each and every die comes with a written lifetime warranty, 2-year guarantee and *guarantee of accuracy or your money back!*

LEE PACESETTER 3-DIE SET 45.98
LEE PACESETTER 2-DIE SET 45.98

The same features as our PaceSetter 3-die set, just in very limited production. Does not include Factory crimp die; rather, a bullet seat and crimp die.

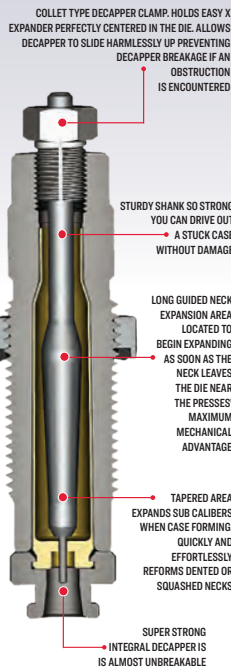

LEE RIFLE DIES FEATURE
THE LEE EasyX EXPANDER



Lee Resizing Lubricant

ANOTHER FIRST BY LEE. We purchased the finest automotive deep draw lubricant and had it custom packaged exclusively for us. Lee lube is pleasant to handle and you can thin with water. Non-sticky, non-allergenic. Very little is needed; it goes a long way. Eliminates stuck and dented cases, and makes sizing less work.
2 OZ. TUBE 90006 5.98

REALLY GREAT BUY!



RGB Dies Compare to other brands costing twice as much and you'll recognize what a fantastic bargain they are. We offer these only to show that when you buy Lee Dies — without all of the extras Lee customers have come to expect — the price is significantly lower, yet the quality is the best. Our tolerance is 50% less than the advertised amount of a popular and expensive brand. We guarantee these dies to be better than any other brand. If for any reason you're not 100% satisfied—just return them to the factory with your sales slip and pay the difference of what you paid and the manufacturer's catalog list price of the dies you want. We will ship them to you with our thanks for trying ours.

These dies are a **Really Great Buy**. They cost less, because like other die makers, we left out \$32.00 worth of extras which are included in our PaceSetter™ dies. Do yourself a favor and check our PaceSetter dies.

RGB Series Dies only 29.98



Spline Drive Bushings

Breech lock quick change bushing with integral lock collar provides unmatched precision and convenience when adjusting dies. Split clamp positively locks die into position.

90063 2-Pk 16.00

Buy more for greater savings



90042 3-Pk 21.00



90095 4-Pk 26.00

COLOR CODED FOR QUICK, POSITIVE DIE SELECTION

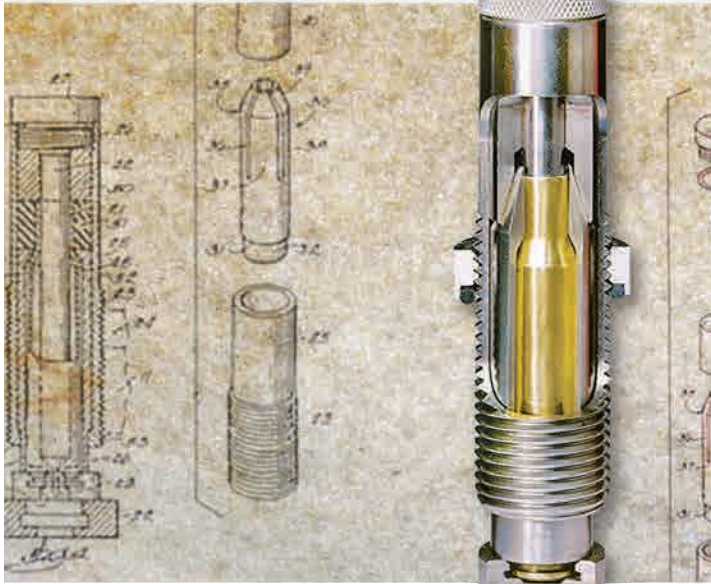

**GUARANTEED TO LOAD
THE MOST ACCURATE
AMMUNITION
OR YOUR MONEY BACK**

- NO LUBRICATION REQUIRED
- GUARANTEED ACCURACY
- EXTENDS CASE LIFE 10X
- FASTEST TO USE
- NO CLEANING OR LUBING REQUIRED

Lee Collet Dies

There is no loading system that will load more accurate ammunition than Lee Collet Dies. We guarantee it in writing with every set. No one but Lee has ever dared make a guarantee like this — **Smallest group size or your money back**. A collet squeezes the case neck against a precision mandrel for a perfect bullet fit with minimum run-out. No case lube is needed. Cases

last ten times longer, so the savings on only 35 cases will pay for the dies.

Maximum accuracy is usually achieved by seating the bullet out far enough to touch or almost touch the rifling. This provides the shot start pressure normally supplied by the crimp. That's why a dead length bullet seater is included to complete the most accurate

reloading system ever made. These dies size only the neck to preserve the perfect fit of fire forming. Only reload cases that have been fired in your gun. Not recommended for autoloaders, slide or lever action guns. See list of sizes on pages 14-15.

Lee Collet Die for neck sizing **48.98**

DIE SETS INCLUDE: COLLET NECK SIZING DIE, DEAD LENGTH BULLET SEATING DIE, SHELL HOLDER, POWDER DIPPER, CHARGE TABLE AND STORAGE BOX. MOST CALIBERS NOT LISTED CAN BE CUSTOM MADE. SEE WEB FOR DETAILS: leeprecision.com/custom-collet-necksizing-die-set.html

Lee Ultimate Rifle Die Set

Choose this die set for maximum versatility. The set features a full length-resizing die to return brass to factory new dimensions, perfect for reloading brass fired in other guns. The Collet Neck sizing die is used on your fire formed brass giving you best possible accuracy. No case lube required and cases last almost forever. The Easy Adjust Dead Length Bullet seating die foolproofs the bullet seating adjustment, and assures perfect seating depth every time. The Factory Crimp Die provides a secure crimp on bullets with or without a crimp groove. In most cases, it helps accuracy by providing a uniform higher start pressure and gives the finished cartridge factory-like accuracy and dependability.

The set is complete with shell holder, powder measure and famous Lee load data featuring all common brands of powder organized in an easy to read logical format.

In addition to best accuracy, you get these benefits

- NO CASE LUBRICATION REQUIRED WITH COLLET DIE
- REDUCED OR ELIMINATES CASE TRIMMING
- TEN TIMES INCREASED CASE LIFE
- UNMATCHED SPEED AND CONVENIENCE
- MINIMUM BULLET RUNOUT
- MOST UNIFORM NECK TENSION

LEE ULTIMATE RIFLE DIE SET **73.00**
INCLUDES COMPLETE COLLET DIE SET PLUS
FACTORY CRIMP DIE, FULL LENGTH RESIZING DIE
& RESIZING LUBRICANT SAMPLE.



**Lee Collet Die
accuracy
contributes
to world record**



While competing in a regularly sanctioned 1000 Yard Match on July 25th, 1993, Robert Frey established a new 1000 yard World Record. We're honored he used the **LEE COLLET DIE** to load his record setting ammunition.

World record breaker Robert Frey commented: *"The Lee Collet Neck Sizing Die enables me to get top accuracy from my rifles [match and hunting]. The design principle of sizing the case neck to a mandrel is unmatched for accuracy potential by any other dies. It is one of the best ways to make all of my rifles shoot their tightest groups."*

FREE SHELLHOLDER INCLUDED WHERE SHOWN

The price of Lee Dies include a FREE shell holder of the proper size. Some manufacturers charge \$15.00 extra for this necessary part.



	RGB DIES P.12	PACESETTER 3-DIE SET P.12	PACESETTER 2-DIE SET P.12	PACESETTER VERY LTD. P.12 PRODUCTION	COLLET DIE SET P.13	ULTIMATE RIFLE DIE SET P.13	COLLET NECK SIZING DIE P.13	.002 UNDERSIZE COLLET MANDREL	FACTORY CRIMP DIE P.9,11	CASE LENGTH GAUGE P.29	UNIVERSAL SHELLHOLDER P.11	PRIMING TOOL SHELLHOLDER P.31	QUICK TRIM DIE BODY P.28
	29.98	45.98	45.98	50.98	48.98	73.00	28.98	5.00	15.98 – 20.00	8.00 – 13.00	5.98	3.98	16.00 – 20.00
17 Hornet		90096							90605	N/A	91499	90020	90611
17 Remington			90770		90804		91000		91571	N/A	90521	90204	90435
204 Ruger		90417			90734		91001		90567	N/A	90521	90204	90439
22 Hornet		90500			90705		91002		90829	90111	91499	90020	90354
218 Bee		90753							90830	90225	90523	90206	91350
221 Fireball		90549							90829	90112	90521	90204	91364
222 Remington	90870	90501			90706		91003		90816	90113	90521	90204	90340
223 Remington	90871	90502			90707	90694	90954	90602	90817	90114	90521	90204	90179
223 Ack. Imp.				90981~	90707		90954	90602	90817	90114	90521	90204	90179
25-45 Sharps				90475*~					91107		90521	90204	
22/250	90872	90503			90708	90739	90955	90602	90818	90116	90519	90202	90284
22/250 Ack. Imp.				90980~	90708		90955	90602	90818	90116	90519	90202	90284
220 Swift		90542			90702		91004		90831	90118	90527	90210	91370
223 WSSM			90446							90673	90522	90205	91358
243 Winchester	90873	90504			90709	90556	90956	90007	90819	90119	90519	90202	90320
6mm Creedmoor		90482			90759		91005	90007	91488	91340	90519	90202	90658
6mm Rem /244 Rem		90540			90710		91006	90007	90832	90120	90519	90202	90434
243 WSSM			90990						90187	90389	90522	90205	91341
25/20 WCF		90750							90833	90121	90523	90206	91385
25/35			90778						91235	91306	90520	90203	
250 Savage/250-3000		90550							90834	90122	90519	90202	91374
257 Roberts		90551			90703		91007		90835	90123	90519	90202	91357
257 Ack. Imp.				90988~	90703		91007		90835	90123	90519	90202	91357
260 Remington		90298			90974		91008	90069	90977	90993	90519	90202	90399
25/06 Rem		90536			90711		90957		90836	90124	90519	90202	90334
25 WSSM			90413								90221	90522	90205
264 Win Mag			90774						91247	91308	90522	90205	
26 Nosler		90081							91163	91307	90522	90205	90637
6.5 Carcano			90749						91229	90043	90519	90202	91353
6.5 Japanese			90730							91331	90527	90210	
6.5 x 55 Swedish Mauser	90874	90627			90712		91009	90069	90837	90126	90520	90203	90337
NEW 6.5 Creedmoor	91556	91821				90939	91012	90069	90704	90814	90519	90202	90812
6.5 PRC				90662					91492	91533	90522	90205	91348
6.5/300 Win Short Mag				90985							90522	90205	
6mm ARC				91562*~	91563*				91664		90529	90212	91665
6.5 Grendel		90557			91606				90596	91278	90529	90212	90763
NEW 6.8 Western				91750					91830		90522	90205	91761
NEW 6.5 Weatherby RPM				91768					91822		90519	90202	91771
270 Win Short Mag		90572							90962	90117	90522	90205	90393
270 Winchester	90875	90505			90713	90593	90958	90496	90820	90128	90519	90202	90229
224 Valkyrie		90066							91487	91339	90599	90031	90868
6.8 Rem SPC		90427							90735	90189	90599	90031	90397
7/30 Waters		90748							90838	91335	90520	90203	
7 x 57 Mauser		90541			90714		91010	90631	90839	90130	90519	90202	90489
7 x 64 Brenneke		90771							90821	90236	90527	90210	91386
7mm/08		90537			90723		91011	90631	90840	90167	90519	90202	90343
7mm Express/280 Rem		90552			90724		91013	90631	90841	90166	90519	90202	90412
280 Ack. Imp.				90989~	90724		91013	90131	90841	90166	90519	90202	91375
7mm Win Short Mag			90573						91271	90314	90522	90205	
7mm Rem Mag	90876	90538			90720	90679	91014	90631	90821	90131	90522	90205	90297
7mm STW		90678							90869	91332	90522	90205	
7mm Ultra Mag		90979							90869	91333	90522	90205	
284 Winchester			90777						91249	90129	90519	90202	91362
7.35 Carcano			90766						91269	91293	90519	90202	
7.5 x 55 Swiss		90767			90186		91015	90480	90184	90132	90520	90203	90419
7.5x54 French MAS		90246							90842	90051	90520	90203	91359
7.62 x 39 Russian	90877	90565			90701		91016		90827	90133	90529	90212	90345
7.62 x 54 Russian		90731			91607				90842	90147	90003	90200	90342

* THESE DIES DO NOT INCLUDE LOAD DATA

~ 3 DIE SET WITH FACTORY CRIMP DIE



FREE SHELLHOLDER INCLUDED WHERE SHOWN

	RGB DIES P.12	PACESSETTER 3-DIE SET P.12	PACESSETTER 2-DIE SET P.12	PACESSETTER VERY LTD. P.12 PRODUCTION	COLLET DIE SET P.13	ULTIMATE RIFLE DIE SET P.13	COLLET NECK SIZING DIE P.13	.002 UNDERSIZE COLLET MANDREL	FACTORY CRIMP DIE P.9,11	CASE LENGTH GAUGE P.29	UNIVERSAL SHELLHOLDER P.11	PRIMING TOOL SHELLHOLDER P.31	QUICK TRIM DIE BODY P.28	1¼-12 THREAD SERIES FACTORY CRIMP DIES P.20	1¼-12 THREAD SERIES COLLET DIES P.20	1¼-12 THREAD SERIES P.20
	29.98	45.98	45.98	50.98	48.98	73.00	28.98	5.00	15.98-20.00	8.00-13.00	5.98	3.98	16.00-20.00	50.00	130.00	130.00
300 AAC Blackout		90575			90772		91017		90590	90443	90521	90204	90689			
300 Ham'R				91564~	91608		91636		91276		90521	90204	91609			
30/40 Krag		90555							90843	90137	90522	90205	91354			
30/30 Win	90878	90506			90716	90693	91018	90480	90822	90136	90520	90203	90249			
30/30 Ack. Imp.				90982~	90716		91018		90822	90136	90520	90203	90249			
303 Savage		90756							90823		90528	90211	91383			
308 Winchester	90879	90507			90718	90695	90959	90480	90823	90139	90519	90202	90231			
300 Win Short Mag		90942			90185		91019	90480	90331	90034	90522	90205	90484			
300 Savage		90545							90844	90138	90519	90202	91356			
30/06	90880	90508			90715	90736	90960	90480	90824	90140	90519	90202	90291			
338/06				90987					90849		90519	90202				
300 Win Mag	90881	90539			90722	90738	90961	90480	90825	90142	90522	90205	90441			
300 H & H		90560			90726		91020		90970	90141	90522	90205	90407			
6.5-300 Weatherby Mag				90983					91493		90522	90205				
300 Weatherby Mag		90558			90727		91020		90845	90143	90522	90205	90408			
300 Ultra Mag		90698							90970	90141	90522	90205	91366			
7.65 Arg Mauser		90732							90846	90134	90520	90203	91382			
7.7 Jap		90733							90847	90115	90519	90202	91368			
25-303		90793							91491		90522	90205				
303 British	90882	90547			90717		91021		90826	90144	90522	90205	90325			
32-40			90758						91239		90520	90203	91376			
32 Winchester Special			90757						91227	90491	90520	90203				
325 WSM			90923						91255	90222	90522	90205	91344			
8x56 R Hungarian			90925						91273	90589	90003	90200				
8x57 Mauser	90883	90544			90719		91022		90848	90148	90519	90202	90347			
8mm Lebel			90768						91272		91497	N/A				
41 Swiss				90411*							90525	90208				
338 Winchester		90546			90721		91023		90849	90149	90522	90205	90391			
338 Ultra Mag			90927						91257	91314	90522	90205				
348 Winchester		90760							90857	91304	90525	90208	91360			
350 Rem Mag			90776						91233	91315	90522	90205	91377			
358 Winchester		90797							90904	91318	90519	90202				
35 Remington		90543			90728		91024		90828	90150	90519	90202	90403			
35 Whelen			90752						91241	90972	90519	90202	91355			
9.3 x 62 Mauser		90654							90610	91299	90519	90202	90614			
375 Ruger		90090							90609	91285	90522	90205	90613			
300 PRC				90224					91494		90522	90205				
375 H & H		90559			90729		91025		90850	90164	90522	90205	90395			
416 Remington		90805							90906		90522	90205				
43 Mauser			90806								91498	N/A				
43 Spanish			90765								91497	N/A	91367			
32-20		90751±	*THESE DIES DO NOT INCLUDE FACTORY CRIMP DIE						90421	90146	90523	90206	91365			
38-40		90761±							90852	91322	90001	90272	91351			
38-55		90762±							90853	90994	90520	90203	91379			
375 Winchester		90563±							90905	90165	90520	90203	91371			
44/40		90564±							90854	90168	90001	90272	91369			
444 Marlin		90562±							90855	90151	90528	90211	91372			
45/70 Government		90561±	45/70 DIES DO NOT WORK ON HORNADY LEVEREVOLUTION CASES						90856	90152	90525	90208	90458			
450 Bushmaster				90182					91167	91325	90519	90202	N/A			
50 Beowulf				90296*		60.98			91738	91292	90529	90212				
350 Legend		90078							90445	91567	90521	90204	91561			
458 Socom				90409					90815	91290	90519	90202	N/A			
458 Win Mag		90800±							90969	90971	90522	90205	91345			
LARGE SERIES THREADED DIES Use with Classic Cast Press p. 20																
338 Lapua			90353								91503	91496		90745	90635	
416 Barrett* SHELLHOLDER NOT INCLUDED										90462	90903▲					90252
577/450 Martini-Henry*											91500					90902
577 Snider*											91500					90929
50 BMG SHELLHOLDER NOT INCLUDED											90903▲			90953	90747	90515

DIE SETS WITH POWDER THROUGH EXPANDING DIE

1½-12 to 1¼-12 DIE ADAPTER BUSHING Use these dies in competitor's press 91697 12.00

* THESE DIES DO NOT INCLUDE LOAD DATA ▲20.00

RELOADING PRESSES LAST A LIFETIME, so buying on what your budget allows makes the most sense. You'll never regret buying a value priced press — you'll always have a need for a simple press for miscellaneous jobs.

SINGLE STATION PRESS OPTIONS

Recommended for new reloaders or those who prefer to batch load



Single Station Presses will load nearly any cartridge. Cartridges are loaded in a batch process—for example, 20 cases are de-primed and sized, charged, then bullets seated. This die changing process is sped up by the Lee Breech Lock Quick-Change System. Rifle case reloading is best accomplished on a single station press. For a beginner, a single station press in a kit is the best value.

Compatible cartridges	Rounds per hour
All cartridges up to 460 Weatherby Mag	50
Breech Lock Challenger Press # 90588 page 19 MSRP \$ 116.00	
Breech Lock Reloader Press # 90045 page 18 MSRP \$63.98	
Compatible cartridges	Rounds per hour
All cartridges up to 50 BMG Accepts both 7/8-14 Threaded Dies and Large Series Threaded Dies 1 1/4-12	50
Classic Cast Press # 90998 MSRP \$ 240.00 see more information on page 20	

All Lee Presses feature compound toggle linkages. This permits full length sizing the largest magnum cases with ease. Many feature built-in spent primer catchers, tough powder paint coating and detailed instructions. Under normal use, all our presses will last a lifetime. For those that simply want the best, you can't beat the "Classic Cast."

THEY ARE THE BEST MONEY CAN BUY!

SINGLE STAGE PRESS KIT OPTIONS

IF YOU ARE JUST GETTING STARTED, YOU CAN SAVE EVEN MORE MONEY BY PURCHASING A KIT



Breech Lock Hand Press Kit #90180 page 18 MSRP \$94.00



Breech Lock Challenger Kit #90030 page 19 MSRP \$259.00



50th Anniversary Kit #90050 page 19 MSRP \$229.00



Bench Prime Press Kit #91628 page 19 MSRP \$268.00

PROGRESSIVE PRESS OPTIONS

RECOMMENDED FOR ADVANCED HIGH VOLUME USERS

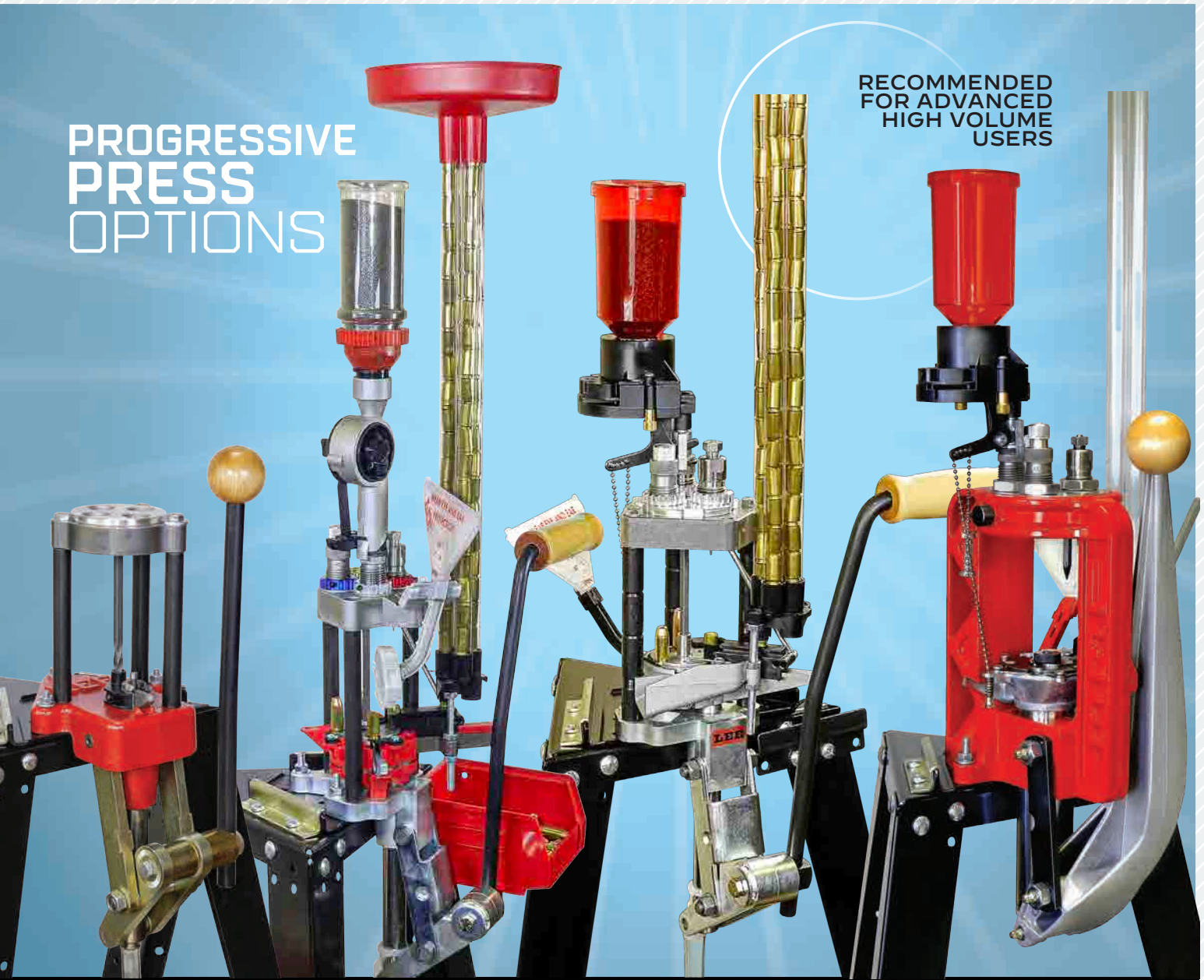

TURRET PRESS

PRO 4000

PRO 1000

LOAD-MASTER

TURRET PRESSES offer single station simplicity with near progressive speed. No need to unscrew dies; the turret advances to the next station automatically. Four pulls of the lever and you have a completed round. Perfect for moderate production of handgun ammunition. Deactivate the Auto-Index feature and you can batch reload the longest rifle cartridges. Twist and exchange the turret, snap in a new shell holder, and you're ready to load your next cartridge.

PRO 4000 Designed with the perfect balance of speed and simplicity. This press is so easy to set up and operate: if you have reloaded before, you likely won't even need to look at the instructions. Cartridge changeover can be completed in seconds. Breech Lock quick change feature in all four positions. You're also going to enjoy using this press for simple case processing like depriming and sizing a batch of cases for tumble cleaning or case trimming. With the auto index deactivated, you can use it as the handiest single station press ever made.

DESIGNED FOR VERY HIGH PRODUCTION of handgun cartridges. Add a bullet and pull the lever; other operations are automatic. Select these presses only if you are shooting more than 500 rounds per week. If loading limited quantities of many different cartridges, a Turret Press or Pro 4000 is your best choice. Changeover from cartridge to cartridge can become involved on the progressive presses.

Compatible cartridges	Rounds per hour
All cartridges up to 460 Weatherby Mag	250
Classic Turret Press # 90064 pg 21 MSRP \$ 210.00	
Value Turret Press # 90932 pg. 22 MSRP \$ 150.00	

Compatible cartridges	Rounds per hour
32 S&W Long to 30/06	500+
Pro 4000 Kit Full description pg 25 MSRP \$ 345.00	
Auto Breech Lock Pro Press only # 90900 pg 25 MSRP \$ 200.00	

Compatible cartridges	Rounds per hour
32 S&W LONG to 223 Remington	500+
Pro 1000 FULL DESCRIPTION PAGE 24 MSRP \$ 340.00	
Compatible cartridges	Rounds per hour
32 S&W LONG to 30/06	500+
Load-Master FULL DESCRIPTION PAGE 25 MSRP \$ 480.00	

COMPACT PRESSES

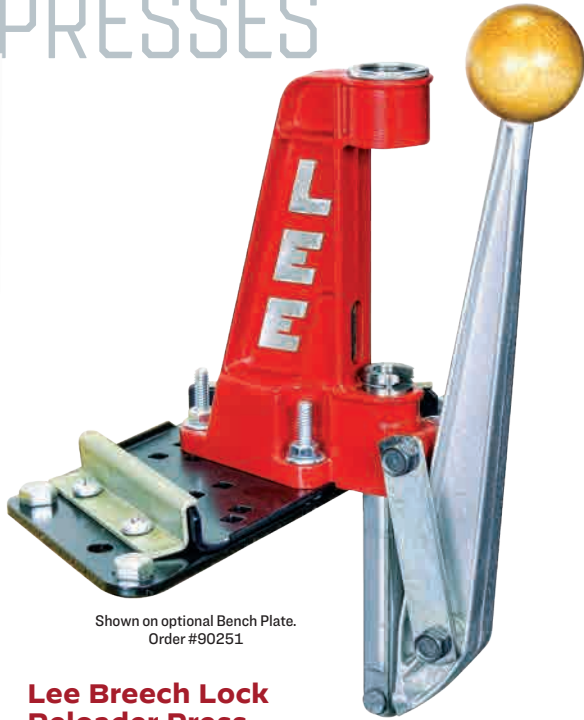

Shown on optional Bench Plate.
Order #90251

Lee Breech Lock Reloader Press

INCLUDES THE BREECH LOCK SYSTEM

An outstanding value. Exclusive balanced lever that can't drop down to pinch your fingers. Unlimited hand clearance that only a "C" frame can offer. Works equally well with the right or left hand. Even if you already own a press, an extra press is always useful for decapping, bullet seating or bullet sizing.

90045 63.98

Lee Breech Lock Hand Press

Features the Lee Breech Lock System. A full size hand held reloading press, yet the tool weighs only 1¾ pounds and costs so little you will want more than one. No matter how much equipment you have, it's great to have a portable hand press. No time is wasted mounting a tool to a work bench. When you're finished—just pack it away.

90685 70.00



BREECH LOCK RAM PRIME

Breech Lock Hand Press Kit

THE PERFECT PORTABLE RELOADING PRESS KIT

Begin reloading at once. No wasted time mounting to a work bench. Pack it all in the box when finished. Great for apartment dwellers or loading at the range. Dies sold separately.

KIT INCLUDES

- BREECH LOCK HAND PRESS
- RAM PRIME
- POWDER FUNNEL
- CASE SIZING LUBE
- 90180 94.00



New, improved Breech Lock Ram Prime

Start priming in seconds, nothing to adjust.

Includes small and large priming assemblies, no tiny parts to fumble with or lose.

Effortless priming in the tightest pockets.

Uses any brand press shell holder.

Safe with all brands of primers.

Works in any Lee Breech Lock press or adapter.

91612 19.98



BIG GUN INSPIRED BREECH LOCK QUICK CHANGE STANDARD ON ALL LEE SINGLE STATION PRESSES

Switch dies with a 1/6 of a turn rather than fourteen or more turns. Loading with a breech lock equipped press is as convenient as a Turret Press when loading small quantities of ammunition. Interrupted three-start thread assures dies will return and lock into the exact same position. If cost is more important than convenience, you can leave the Breech Lock bushing locked in the press and screw dies in and out like a conventional press.



Change dies instantly with a twist of the wrist

Spline Drive Bushings

Breech lock quick change bushing with integral lock collar provides unmatched precision and convenience when adjusting dies. Split clamp positively locks die into position.

90063 2-Pk 16.00



Buy more for greater savings

90042 3-Pk 21.00



90095 4-Pk 26.00



Color coded for quick, positive die selection

Breech Lock Bushings

Breech lock bushings fit all Lee Breech Lock presses. Allows instant, accurate die changes.

90600 2-Pk. 12.98



Lee Ram Prime

Primes on the press up-stroke for a more sensitive feel. Includes small and large priming assemblies; no tiny parts to fumble or lose. Fits all brands of presses. Use on old school presses, where you need to thread in dies.

90106 19.98



**"O" FRAME ...
MOST POPULAR
STYLE PRESS
BY FAR**



Breech Lock Challenger Press

The "O" frame press by design is the strongest and most popular style press by far. Large opening and long stroke handles the largest belted magnums with ease. The primer catcher is positive and routes the spent primers directly to the trash can. Priming is a dream with the LEE LEVER PRIME SYSTEM. Best of all, it includes the BREECH LOCK QUICK CHANGE DIE SYSTEM. Change dies instantly with a twist of the wrist; you'll never have to re-adjust your die.

Other features include all steel linkage with adjustable length lever. This same press would cost you more than twice as much from other manufacturers, and that's without all of the Challenger's features.

90588 116.00



Primer Arms



LARGE & SMALL SAFETY PRIME
90997 30.00

SEE DESCRIPTION PAGE 22



Shown on optional Bench Plate. Order #90251

50TH ANNIVERSARY KIT

A COMPLETE POWDER HANDLING SYSTEM with the most convenient and repeatable PERFECT POWDER MEASURE, plus the LEE SAFETY SCALE, the most sensitive, safest of all powder scales. Fill your cases with the POWDER FUNNEL.

Case Preparation tools include the LEE VALUE TRIM case trimmer to trim on your reloading press (order cartridge specific trim die separately on pg. 28), and a CUTTER & LOCK STUD to trim your cases. (Order cartridge specific case length gauge separately on pg. 28-29). The LEE CHAMFER TOOL chamfers the inside and outside of the case mouth, and a tube of premium SIZING LUBE is also included. A small and large PRIMER POCKET CLEANING TOOL completes the case preparation package.

But that's not all! You get the large and small SAFETY PRIME. Prime with push button convenience and is safe with all brands of primers. Never touch the primer from box to the case.

Purchased separately \$268.86 value 90050 229.00



BENCH PRIME PRESS KIT

Featuring all the components of the 50th Anniversary Kit, but we've replaced the SAFETY PRIME with the AUTO BENCH PRIME, along with 3 of the most popular Auto-Prime shell holders which work with over 60 different cartridges.

This kit is ideal for those who want to prime on the workbench. If you purchase all components separately—it's a \$294.78 value.

91628 268.00



Shown on optional Bench Plate. Order #90251

BREECH LOCK CHALLENGER KIT

Features the same components as the 50th Anniversary Kit, but we have replaced the Safety Prime with the New Auto-Prime and a set of three of the most popular Auto-Prime shell holders.

This kit is for those who prefer to prime off the press.

If purchased separately—a \$282.78 value.

90030 259.00

HAVE AN OLD SCHOOL PRESS AND THREAD DIES INTO REMOVABLE, THREADED ADAPTER? MODERNIZE YOUR PRESS WITH THE BREECH LOCK SYSTEM

90512 1¼-12 15.00
90094 1½-12 16.00

PRESS NOW INCLUDES BREECH LOCK ADAPTER

Gives you the ability to quick change dies or remove the adapter to load the mammoth 50 BMG

BAKED POWDER FINISH AND ALL STEEL LINKAGE MAKE THE LEE CLASSIC CAST PRESS THE MOST ATTRACTIVE AND DURABLE PRESS MADE

RIGID CAST IRON FRAME, CAST AND MACHINED WITH PRIDE IN THE USA

LEE CLASSIC CAST PRESS
90998 240.00

- ▶ The industry's largest opening, and longest stroke—handle adjusts to provide least travel of any press.
- ▶ Largest ram, 1½" diameter, supported by over 12 square inches of ram bearing surface.
- ▶ Spent primer disposal direct to trash can with attached tube.
- ▶ Powerful compound linkage with positive travel stop prevents press toggle or "cam over."
- ▶ Rigid cast iron construction in a classic "O" design for maximum strength. Baked powder coating is durable and makes a handsome addition to any reloading bench.
- ▶ Large, flat cored base with 3 mounting holes, mounts solid to any bench.
- ▶ Automatic primer arms with bottom of stroke priming for best feel. Includes both large and small priming arms. No more fumbling with tiny guides and springs when changing primer size.

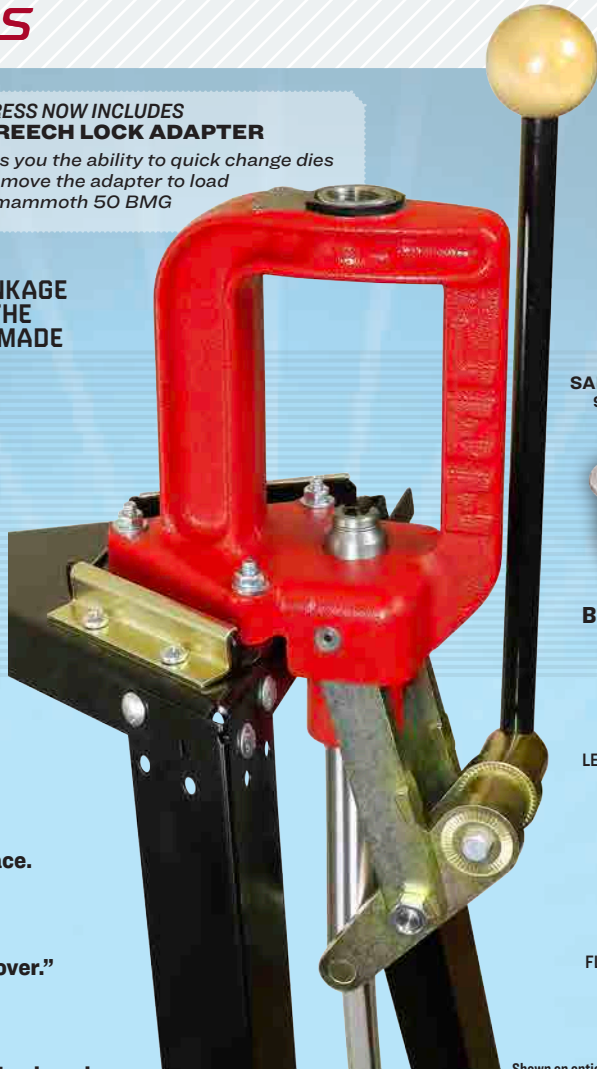

Shown on optional Reloading Stand. Order #90688

- ▶ Designed to work with both standard 7/8-14 and large series 1¼-12 dies. Included Breech Lock adapter to accept standard 7/8-14 dies. Change dies instantly with a quick twist of the wrist.
- ▶ Two-piece ram allows installation of the mammoth 50 BMG shell holder or the shell holder insert for standard press shell holders. Shell holder insert can be rotated to allow primer installation on the right or left side.

▶ LARGE & SMALL SAFETY PRIME
90997 30.00



▶ NEED BUSHINGS?
page 9



▶ CHANGES EASILY FOR LEFT-HANDED USE.

▶ SPENT PRIMERS COLLECTED AND DROPPED INTO FLEXIBLE PLASTIC TUBE FOR EASY EMPTYING.



50 BMG Loading Block
Block dimensions 9" x 8"
High impact, chemical resistant plastic
Holds 72 cases, can also be used to store 7/8 - 14 die sets
Continuous flange surrounds tray for easy lifting.
90632 15.00



1½-12 to 1¼-12 Die Adapter Bushing
Use the Lee 50 BMG and other 1¼ series dies in competitor's 50 BMG large presses. 91697 12.00

LARGE SERIES RELOADING DIES

1¼-12 Thread Series Factory Crimp Dies 50.00
90953 50 BMG
90745 338 Lapua

1¼-12 Thread Series Collet Dies 130.00
90747 50 BMG
90635 338 Lapua

1¼-12 Thread Series 130.00
90902 577/450 Martini-Henry *
90929 577 Snider *
90252 416 Barrett *
Shellholder not included
90515 50 BMG
Shellholder not included

*These dies do not include load data



50 BMG Die Set 1¼-12 Thread
90515 125.00

50 BMG Factory Crimp Die
90953 50.00

50 BMG Shell holder
90903 20.00

50 BMG Ram Prime Tool
90901 25.00

CLASSIC CAST 50 BMG PRESS KIT

AT LAST, AN AFFORDABLE WAY TO RELOAD THE MONSTER 50BMG

KIT INCLUDES EVERYTHING YOU NEED TO START RELOADING THE 50

LEE CLASSIC CAST PRESS • SET OF 50 BMG DIES
SHELL HOLDER • RAM PRIME TOOL • AND TUBE OF CASE SIZING LUBE

BREECH LOCK ADAPTER KIT also includes shell holder insert, large & small primer arms and breech lock adapter bushing to accept standard 7/8-14 dies so you can load all your smaller cartridges. All this for less than what others charge for dies alone.

50 CALIBER BMG PRESS KIT
90859 375.00



Lee Classic Turret Press

The sturdy iron base shows its Classic Cast roots. The long stroke allows rifle cases over three inches long to be loaded using the automatic index. Deactivate the Auto-Index and cases over 4 inches can be loaded. The rigid cast iron frame supports the ram with over 12 square inches of area. The industry's largest ram is drilled completely through to dispose primers in an attached clear PVC tube. Every primer is caught — guaranteed.

Instant change turrets are the same as the famous Lee Turret Press. The Classic Turret uses the Lee Lever Prime System · LPS and the optional Lee Safety Prime tool makes priming on the press a delight. If you like to own the best, then treat yourself to the Lee Classic Turret. The finest reloading system made.

LEE CLASSIC TURRET PRESS 90064 210.00

Shown on optional Reloading Stand. Order #90688

A MACHINE THAT DOES IT ALL

This press has all the features of the award-winning Turret Press with the quality touches that make this the finest, most convenient press to own. The Classic Turret features the solid steel linkage of the Lee Classic Cast. Your first stroke of the hardwood gripped lever will convince you this is one solid, silky smooth press!



Lee Safety Prime

Makes priming on the press a delight. Never touch the primers from box to shell. Primer flip tray features a CAD designed flipping surface that instantly rights the primers. Change primer size in seconds. Primers are dispensed with a satisfying click of the primer feed trigger.

90997 30.00

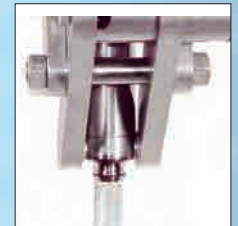
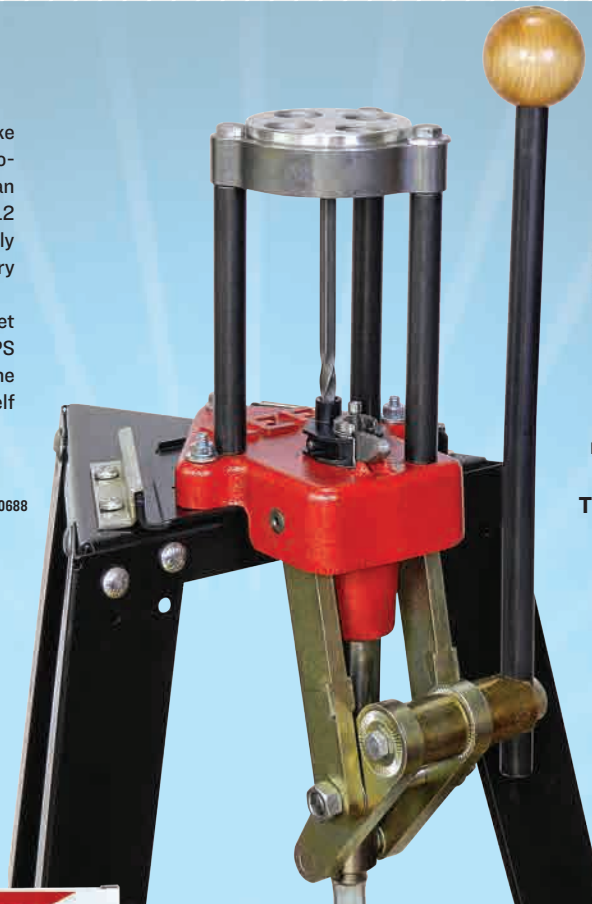

SPENT PRIMERS COLLECTED AND DROPPED INTO FLEXIBLE PLASTIC TUBE FOR EASY EMPTYING.



POWDER MEASURE RISER FOR SAFETY PRIME
90041
See page 33



GET AN ADDITIONAL TURRET FOR YOUR LEE PRESSES
EXTRA TURRET, 4 HOLE
90269 15.00



CLASSIC TURRET PRESS KIT

THIS KIT AND A SET OF LEE DIES IS EVERYTHING YOU NEED TO BEGIN RELOADING PISTOL AMMO. The Classic Turret Press is fast and convenient when loading handgun cartridges, with rates in excess of 250 rounds per hour possible.

The kit includes the Auto-Drum powder measure and powder measure riser, perfect for all handgun and rifle cartridges. Large and Small Safety Prime are included making on press priming a delight! Instant Change Turret makes changing calibers a snap. Deactivate the auto-index, and batch load the longest and largest rifle cartridges.

Complementing your press kit are the case conditioning tools to prepare your brass for loading. Includes Cutter, Lock Stud, Chamfer Tool, small and large Primer Pocket Cleaner, and a tube of Lee case sizing lube. Complete it with the cartridge specific Case Length Gauge. Verify your loads with the included Lee Safety powder scale.

Completing the kit is *Modern Reloading Second Edition*, 2021 revision with all new load data covering over 170 cartridges with more than 38,000 loads.
90304 370.00



Shown on optional Bench Plate. Order #90251

NOTE Rifle reloaders require **SHORT or LONG CHARGING DIE** | see page 33



Shown on optional Reloading Stand. Order #90688

Low profile steel base with positive through ram primer disposal

Built-in primer disposal tube



VALUE TURRET PRESS

EQUIPPED WITH THE **LEE LEVER PRIME SYSTEM™**

Proven design with compound leverage. No spring in this turret design. The turret is locked into a solid steel ring with big rifle bolt type lugs. Exclusive design puts the lugs on the circumference so there can be no tipping. The linkage is so powerful that the largest magnum cases are sized with ease. Effort required is so small that the usual heavy bench is not essential. The Lee Turret Press has built-in primer disposal tube and a comfortable roller handle. Even if you do not need all of these features, why pay more for anything less?

Power and strength to spare, plus unequalled convenience. The Lee Turret Press is suitable for loading all rifle and pistol cases, but really shines when loading large quantities of handgun ammunition. This is the most convenient press made. Only a true progressive press is faster. Includes the **LEE LEVER PRIME SYSTEM** with large and small primer arms. Works with the Lee Safety Prime.

4 HOLE TURRET PRESS w/Auto Index 90932 150.00



Lee Safety Prime

Makes priming on the press a delight. Never touch the primers from box to shell. Primer flip tray features a CAD designed flipping surface that instantly rights the primers. Change primer size in seconds. Primers are dispensed with a satisfying click of the primer feed trigger.

90997 30.00



POWDER MEASURE RISER FOR SAFETY PRIME
90041
See page 33

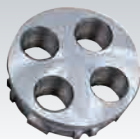

GET AN ADDITIONAL TURRET FOR YOUR LEE PRESSES
EXTRA TURRET, 4 HOLE
90269 15.00

Lee Value Turret Press Kit

The Value Turret Press, along with the Auto-Drum Powder Measure, produces top quality pistol ammo in a hurry.

A finished round with a few pulls of the lever. Disconnect the Auto-Index and it's large enough to handle monster belted magnum rifle cases. When it's time to change calibers, simply lock in a new turret and begin reloading in seconds. In addition to the Turret Press and Auto Drum Powder Measure, the kit includes the Lee Safety Scale, unmatched for sensitivity, a primer pocket cleaner, cutter and lock stud to trim the cases and a chamfer tool to deburr cases after trimming. Complete the case conditioning tools with the cartridge specific Case Length Gauge (see page 28).

A set of Lee Dies is all that is required to complete this reloading outfit. And all of this at a price that will allow you to pay for your investment in a matter of hours.

VALUE TURRET PRESS KIT 90928 260.00



Shown on optional Bench Plate. Order #90251

NOTE Rifle reloaders require **SHORT** or **LONG CHARGING DIE** | see pg 33

PROGRESSIVE PRESS SHELL PLATES



PRO1000
POSITIVE INDEX
SHELL PLATES
20.00



PRO 4000
SHELL PLATES
25.00



LOAD-MASTER
SHELL PLATES
29.98

PRODUCT NO.	PLATE	CARTRIDGES
90651	1	38 SPECIAL, 357 MAG, ETC.
90652	2	45 ACP, 45 GAP, ETC.
90664	3	45 WINCHESTER MAGNUM
90653	4	222, 223, 380 AUTO, 32 S&W LONG, 32 H&R MAGNUM
90976	6	32/20, 25/20
90655	7	30 M1 CARBINE, 32 AUTO
90656	9	41 MAGNUM
90657	11	44 SPECIAL, 44 MAGNUM, 45 COLT
90666	12	7.62X39, PPC, 220 RUSSIAN
90665	13	45 AUTO RIM
90065	14	38/40, 44/40, 45 COLT, 460 S&W
90669	19	40 S&W, 10mm AUTO, 9MM LUGER, 38 SUPER, 38 AUTO, 41 AE

PRODUCT NO.	PLATE	CARTRIDGES
90582	1	38 SPECIAL, 357 MAG, ETC.
90584	2	45 ACP, 45 GAP, ETC.
90629	3	45 WINCHESTER MAGNUM
90630	4	222, 223, 380 AUTO, 32 S&W LONG, 32 H&R MAG
90647	7	30 M1 CARBINE, 32 AUTO
90278	9	41 MAGNUM
90648	11	44 SPECIAL, 44 MAGNUM, 45 COLT
90414	12	7.62 x 39 RUSSIAN, 6.5 GRENDDEL
90649	13	45 AUTO RIM
90802	14	38/40, 44/40, 45 COLT, 460 S&W
90659	16	500 S&W, 7.62X54R
90944	19	40 S&W, 10MM AUTO, 9MM LUGER, 38 SUPER, 38 AUTO, 41 AE
90941	21	6.8 SPC, 224 VALKYRIE

PRODUCT NO.	PLATE	CARTRIDGES
90907	1S	38 SPECIAL, 357 MAG, ETC.
90908	2L	45 ACP, 30/06, 308, 6.5 CREEDMOOR
90909	3L	30/30, 7x30 WATERS, 7.5 SWISS
90910	4S	222, 223, 380 ACP
90059	4A	32 S&W LONG, 32 H&R MAG., ETC
90911	5L	BELTED MAGNUMS 300 MAG 303 BRITISH , 30/40 KRAG, 7MM WSM 32/20, 25/20, ETC.
90912	6S	30 M1 CARBINE, 32 ACP
90913	7S	45/70, 348 WIN, 416 RIGBY
90914	8L	41 MAGNUM
90915	9L	220 SWIFT, 6.5 JAP, 458 SOCOM
90916	10L	44 MAG., 44 SPL., 45 COLT
90917	11L	7.62X39, 6MM PPC, 22 PPC, ETC.
90918	12L	44/40, 38/40, 45 COLT, 460 S&W
90919	14L	500 S&W, 7.62X54R
90612	16L	9MM LUGER, 40 S&W, 38 SUPER, ETC.
90920	19S	10MM AUTO
90068	19L	22 HORNET
90884	20	6.8 REM SPC, 224 VALKYRIE
90984	21L	

Check shell holder chart on page 31 for further listings.

ACCESSORIES FOR THE PRO 1000 · PRO 4000 · LOAD-MASTER



UNIVERSAL CASE FEED MAGAZINE

90242 **35.00**
Automates case feeding process. Cartridge compatibility listing on leeprecision.com

EXTRA CASE FEEDER TUBES

7 Pk. 90661 **9.98**

CASE COLLATOR

Fill all four tubes in just 10 seconds. Works with handgun, .380 to 45 Colt.

90667 **14.98**



BULLET FEED KIT IS COMPLETE FOR ONE BULLET DIAMETER AND RANGE OF LENGTH. TO CONVERT TO ANOTHER CALIBER OR BULLET LENGTH, SELECT APPROPRIATE FEED DIE AND FINGER & BULLET SEAT AND FEED DIE **48.00**

FEED KITS COMPLETE	DESCRIPTION	FEED DIE AND FINGERS
90892	30 & 32 cal Bullets up to .60 long	90885
90893	9mm through .365 diameter up to .46 long	90886
90894	9mm through .365 diameter .46 to .60 long	90887
90895	9mm through .365 diameter .60 to .75 long	90888
90896	40 cal through .44 cal up to .65 long	90889
90897	40 cal through .44 cal .65 to .80 long	90890
90898	45 cal bullets .50 to .67 long	90891

Multi-Tube Adapter for Bullet Feed Kit

Four tube magazine keeps Lee Bullet Feeder fed with a continuous supply of bullets. Each tube holds approximately 25 bullets. Quickly and easily installed. Includes large and small adapters, four large and small feed tubes and cylinder, plate assembly.

90280 **28.00**



FOR THE LOAD-MASTER



LARGE PRIMER FEEDER

90077 **24.98**

SMALL PRIMER FEEDER

90075 **24.98**



FOLDING PRIMER TRAY 2-PK

90606 **8.00**



LEE PRO 1000 KIT

INTRODUCED IN 1984 as the *world's first affordable progressive press*. Place a bullet and pull the lever; all other operations are automatic. Load singly or progressively, feeds powder and primers only if case is present.

Recently improved design with **better ergonomics, steel frame, positive index pin, roller handle and positive through ram primer disposal.**

Ergonomic wood grip and all-steel linkage

- | | |
|----------------------------|--------|
| 32 S&W LONG AND 32 H&R MAG | 90639* |
| 380 AUTO | 90641* |
| 38 SPECIAL AND 357 MAGNUM | 90636 |
| 38 AUTO AND 38 SUPER | 90035 |
| 9MM LUGER | 90640 |
| ‡ 40 S&W | 90682 |
| 41 MAGNUM | 90642 |
| 44 SPECIAL AND 44 MAGNUM | 90634 |
| 45 ACP | 90638 |
| 45 COLT | 90643 |
| 223 | 90633* |

INCLUDES SHORT CHARGING DIE.
NOT AVAILABLE IN CARBIDE

*INCLUDES AUTO-DRUM POWDER MEASURE
‡ 10MM AUTO CAN BE RELOADED. PURCHASE
LARGE TROUGH #TR2164B, PIN #TR2436 AND
10MM LOAD DATA #C41311

LEE PRO 1000
COMPLETE, READY TO RELOAD
340.00

Safe with CCI or Remington brand primers only

◀ Built-in primer disposal tube

TURRET
90497
19.00



ADD A BULLET AND PULL THE LEVER
ALL OUR PROGRESSIVE PRESSES WILL PRODUCE A RELOADED ROUND WITH EVERY STROKE. BECAUSE EVERY PULL OF THE LEVER PRODUCES A LOADED ROUND - PRODUCTION

PRO 4000

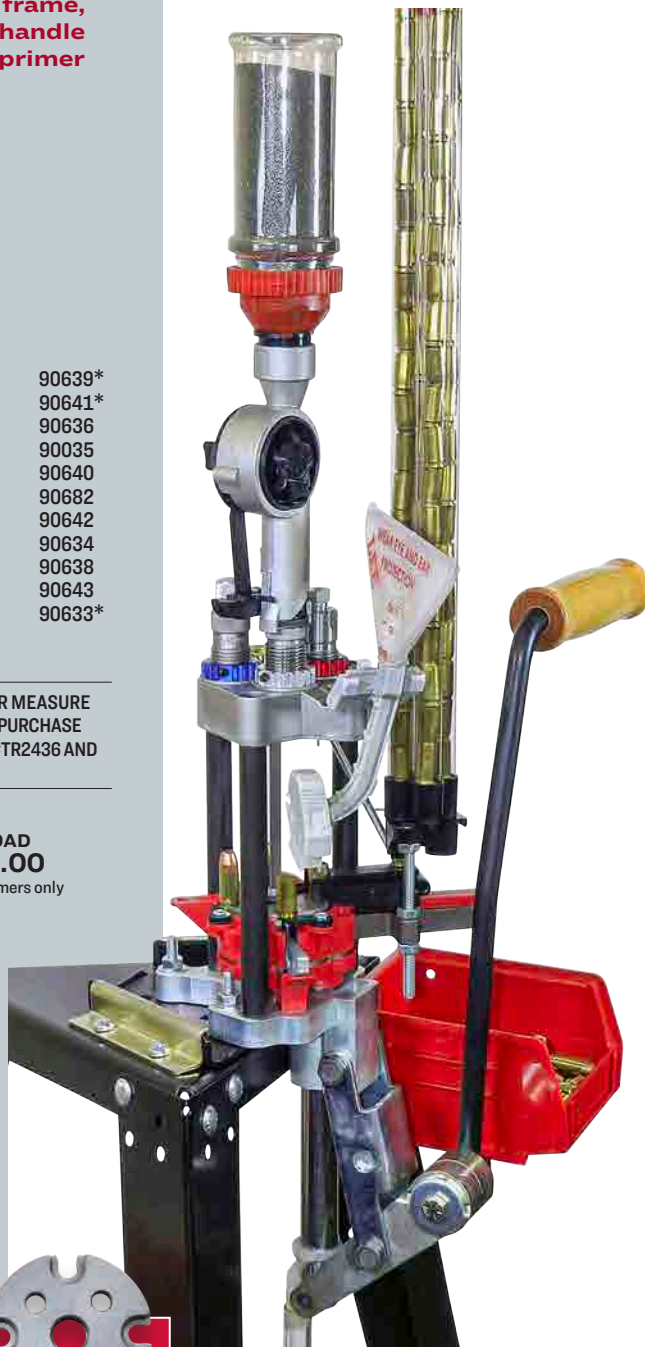

Cartridge changeover in seconds, including primer size with no adjustments.



SHELL PLATES FOR PRO 4000 shown on page 23

- | | |
|---------------------------|-------|
| 45 ACP | 91550 |
| 9mm LUGER | 91555 |
| 38 SPECIAL AND 357 MAGNUM | 91557 |
| 44 SPECIAL AND 44 MAGNUM | 91558 |
| 223 REMINGTON | 91551 |

- Automatically advances cases up to 2⁵/₁₆"
- Quick Change three die turret
- Set up for specific cartridge and one primer size
- Safe with CCI or Remington brand primers only
- Bullet seating and crimping performed in one operation

BIN & BRACKET Catch your loaded rounds. See page 4 90687 **14.00**

RATES ARE VIRTUALLY IDENTICAL ON OUR PROGRESSIVE PRESSES. ALL OF OUR PRESSES FEATURE AUTOMATIC CASE ADVANCE AND UNIVERSAL CASE FEEDER. ALL ARE SETUP TO LOAD ONE CARTRIDGE. YOU CAN SELECT THE RIGHT PRESS BY THE FEATURES YOU NEED.

KIT SECOND-GENERATION progressive press priced less than many premium single station presses, the lowest priced four- station progressive available. It is also the easiest to use progressive press ever made. Everything included to begin reloading nothing else to buy.

All the features of the Pro 1000 with an **added fourth station** to allow factory crimping and post sizing. Second generation design features a fixed tool head with quick-change bushings. The Safety Prime is safe with all brands of primers and makes on press priming fast and dependable. The ideal press for loading well used or mixed range brass. So easy to change you're going to enjoy using this press for simple case preparation, like depriming before tumble cleaning. Deactivate the auto index and it is the handiest single station press ever made.

AUTOMATICALLY ADVANCES cases up to 2 5/16." Longer cartridges can be loaded by manually advancing.

AUTOMATIC Universal Case Feed Magazine

MODULAR CONSTRUCTION allows as much or as little automation as the operator desires with no adjustments.

CARTRIDGE CHANGEOVER in seconds, including primer size with no adjustments. Color coded spline drive quick change breech lock bushings.

INCLUDES Large and Small Safety Prime and priming arms. Allows safe dispensing of any brand and size primer.

INCLUDES STORAGE RACK FOR TOOLS, AND HEX WRENCH FOR SHELL PLATE CHANGEOVER. OTHERS CHARGE NEARLY \$30 FOR THIS FEATURE.

INCLUDES ERGONOMIC WOOD GRIP ROLLER HANDLE. OTHERS CHARGE NEARLY \$50.00 FOR THIS FEATURE.

INCLUDES BIN & BRACKET TO CATCH LOADED ROUNDS.

LOAD-MASTER

A MASSIVE PRESS WITH ADVANCED FEATURES



SHELL PLATES FOR LOAD-MASTER shown on page 23

SHOWN ON OPTIONAL RELOADING STAND #90688



Precision 5-Hole Turret with 20 locking lugs takes just seconds to change.
90079 16.00



BIN INCLUDED ORDER ADDITIONAL #90687

Explosion Shield INCLUDED 90363 10.00
Necessary if using primers other than CCI or Remington brand

CALIBERS EQUIPPED WITH RELOADING DIES, PRO AUTO-DISK POWDER MEASURE & CASE FEEDER **480.00**

223 REMINGTON	90922*
32 S&W LONG • 32 H&R MAG	90935*
9MM LUGER	90936
380 AUTO	90937*
38 SPECIAL AND 357 MAGNUM	90938
40 S&W †	90940
44 SPECIAL AND 44 MAGNUM	90943
45 ACP	90945
45 COLT (WILL LOAD 454 CASULL)	90946

* INCLUDES AUTO-DRUM POWDER MEASURE † 10MM AUTO CAN BE RELOADED. PURCHASE LARGE PRIMER FEEDER #90077 AND 10MM LOAD DATA #C41311



Large Primer Feeder 90077 24.98
Small Primer Feeder 90075 24.98

Grease fittings, along with a 1 3/4 inch diameter hard plated ram, ensure a lifetime of service for even the commercial reloader

Stroke and clearance sufficient for largest magnum rifle cases

Loads long rifle cartridges progressively

Load progressively or singly without spilled powder or components.

Five stations so you can factory crimp and post size.

Automatic indexing

Tray feed top of stroke priming system

Removable turret

Loaded round ejector and case catcher

Quick change shell plate. No tools required

LEE PRO 4000 KIT

INSTALL AUTO BREECH LOCK PIN;
ADJUST YOUR DIES AND BEGIN RELOADING
345.00

AUTO BREECH LOCK PRO PRESS ONLY #90900 **200.00**

Auto Breech Lock Pro Press	200	PURCHASED SEPARATELY, VALUED OVER \$427
Large & Small Safety Prime	30	
Auto Drum Powder Measure	54	
Shell Plate	25	
Universal Case Feeder	35	
Reloading Dies	43	
Bin & Bracket	14	
Color Coded Spline Drive Bushings	26	

FAST AND EASY

THE LEE APP AUTOMATIC PROCESSING PRESS

The fastest and easiest way to deprime, size, swage, bulge bust, flare or size cast bullets, period!

Built in case and bullet feeder makes this the fastest single station press ever made.

Frameless design with an all steel linkage allows primer pocket swaging with ease.

Counter balanced handle prevents the handle from falling and pinching a finger.

Almost unlimited visibility and hand clearance.

Compact footprint mounts easily on any bench or table, with no under-swing.

Dirty, gritty, lead contaminated spent primers are 100% captured in a screw top bottle.

Accepts standard 7/8-14 dies and shell holders of any manufacture.

A little over three inches of stroke allows sizing of the larger, belted magnum cartridges.

Priced less than nearly all single station presses makes it a perfect starter press or a perfect companion press to an expensive progressive.

Includes the three most popular X-Press Shell holders 2, 4 and 19



APP Press INCLUDES PRESS, AUTOMATION KIT, BOTTLE ADAPTER AND X-PRESS SHELLHOLDERS 2·4·19
90933 140.00 MSRP

COMES COMPLETE WITH ALL FEED TUBES, TUBE SUPPORTS, RISERS AND CASE SLIDER



Dirty, gritty, lead contaminated spent primers are 100% captured in a screw top bottle



ROLLER HANDLE UPDATE KIT
91629 30.00

APP shown on optional Reloading Stand #90688 with Bin & Bracket accessory #90687



X-PRESS SHELL HOLDER FOR APP
AUTOMATIC PROCESSING PRESS
4.98 ea



X-PRESS SHELLHOLDER SET
CONTAINS 1·2·3·4·5
7·8·9·10·11·19
91622 41.00

X-PRESS SHELLHOLDER

The APP gets its speedy operation in part, by the use of a new shell holder. We call it the X-Press Shell Holder. It allows the case to pass through the shell holder after the operations are performed.

APP SHELL HOLDER	PRODUCT NO.	CARTRIDGES
#1	91534	38 Long & Short Colt, 38 SPL, 357 MAG
#2	91535	45 ACP, 308 Win., 30-06
#3	91536	30/30, 6.5x55 Mauser, 32/40
#4	91537	223 Rem, 5.56 NATO, 300 Blackout
#5	91538	WSM's, 7mm Rem Mag, 303 British
#6	91539	218 Bee, 25/20, 32/20
#7	91540	30 M-1, 32 ACP
#8	91541	33 Win, 348 Win, 40/65, 45/70
#9	91542	41 Magnum
#10	91543	220 Swift, 6.5 Jap, 7x64 Brenneke
#11	91544	44 SPL/MAG, 45 Colt, 303 Savage
#12	91545	22 PPC, 6 PPC, 7.62x39R
#13	91546	45 Auto Rim
#14	91547	44/40, 45 Long Colt
#15	91548	25 ACP
#16	91549	7.62x54 R, 500 S&W
#19	91552	40 S&W, 9mm Luger
#20	91553	17 HORNET, 22 HORNET
#21	91554	6.8 Rem SPC, 224 Valkyrie

BULGE BUSTER KIT

FOR THE LEE APP



Lee APP Bulge Buster Kit with appropriate Lee Factory Crimp Die restores free function of rimless cases that have low base bulges. Low base bulges usually occur from chambers that do not fully support the cartridge or cases resized in carbide dies from manufacturers other than Lee.

APP BULGE BUSTER KIT 91572 24.98 See page 7 for corresponding FACTORY CRIMP DIE



BREECH LOCK BULLET SIZING KIT

FOR THE LEE APP



Breech Lock Bullet Sizing Kit

THE KIT INCLUDES THE MOUNTING BODY INCORPORATING THE LEE QUICK CHANGE BREECH LOCK FEATURE. The body accepts our new low cost bullet sizing die. The new sizing die is high carbon steel and specially tapered to reduce sizing effort. The sizing die is retained in the mounting body with a dual threaded bottle adapter. Bullets are sized nose first; this is the most accurate and causes the least distortion. Best of all no special top punches are required. Will seat and crimp gas checks while sizing.

Great for powder coated or liquid lubricated bullets. All bullets must be lubricated, order LEE LIQUID ALOX or your favorite coating.

91532 15.00
ORDER BULLET SIZER AND PUNCH BELOW
BULLET SIZER AND PUNCH 12.00



Other sizes can be made on a custom basis.
leeprecision.com/custom-breech-lock-bullet-sizer-punch.html

PART №	DIAMETER	PART №	DIAMETER	PART №	DIAMETER
91505	.224	91514	.314	91523	.427
91506	.225	91515	.323	91524	.429
91507	.243	91516	.329	91525	.430
91508	.278	91517	.339	91526	.451
91509	.284	91518	.356	91527	.452
91510	.285	91519	.357	91528	.454
91511	.308	91520	.358	91529	.457
91512	.309	91521	.401	91530	.501
91513	.311	91522	.410	91531	.510

UNIVERSAL CASE EXPANDING DIE



Gently flares the case mouth to accept cast bullets without shaving. Works great to prevent damaging the moly and low friction coatings found on today's high performance jacketed bullets. Includes neck plugs for .22 cal through .45 cal. Works on everything from the 22 Hornet to the largest Ultra Mag. Costs so little and works so well you can't afford to be without one.

90798 18.00



Breech Lock Ram Prime

Start priming in seconds, nothing to adjust. Includes small and large priming assemblies, no tiny parts to fumble with or lose. Effortless priming in the tightest pockets. Uses any brand shell holder. Safe with all brands of primers. Works in any Lee Breech Lock press or adapter.

91612 19.98

PRIMER POCKET SWAGE KIT

DESIGNED EXCLUSIVELY FOR THE LEE APP PRESS

Now you can swage primer pockets as fast as you can operate the press lever



The fastest, most convenient way to swage primer pockets. Will swage large and small primer pockets on any case up to 2½ inches (30/06) long.

No shell holders required!

Large and small swage punches included.

Exclusive, case guided swage push die works without adjustment. It automatically aligns your case mouth to receive the push rod and six guide fingers center the primer pocket to the swage punch. Nothing to adjust—simply install and begin swaging.

Swage adjustment is a finger adjustable knob, no tools required.

APP PRIMER POCKET SWAGE KIT 90237 51.00



OPTIONAL CASE COLLATOR #90667 pg 23



UNIVERSAL CASE FEED MAGAZINE

90242 35.00
Automates case feeding process. Most handgun and short rifle, like the 223.

NEW



APP DEPRIME KIT

World's fastest, most convenient deprimer. Universal, no shell holder required.

91855 25.00

TWO GREAT WAYS TO TRIM CASES QUICK TRIM OR CASE LENGTH GAUGE

FOR SAFETY SAKE, TRIM YOUR CASES

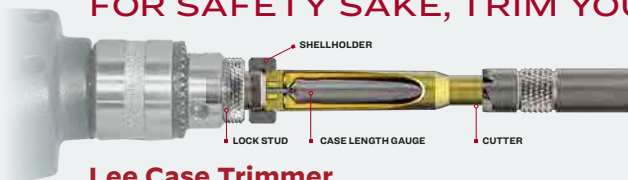

The simplest way to check the case and trim to the correct safe length is with a Lee Case Trimmer.

Lee Case Trimmer

After a case has been loaded a few times, it will stretch beyond maximum length and must be trimmed. There is no better system to check and trim cases than with the Lee Case Length Gauge and cutter. You don't need an expensive caliper to set length and never waste even a single case setting up with the cut and try system common to all other brands. The piloted cutter assures the case mouths are absolutely square and true to the case neck. Best of all, the fixed length design assures it will never go out of adjustment.

The Cutter and Lock Stud works for all calibers. You will need only one. The Case Length Gauge (Pilot) and Shell Holder must be ordered as Case Length Gauge and Shell Holder for each caliber — see chart listing at right and opposite page. You can trim cases by hand, use an electric drill.



CUTTER and LOCK STUD 90110 6.98
Fits cases up to .468" in diameter.
LARGE CUTTER & LOCK STUD 90401 9.98
Can be used on any case.

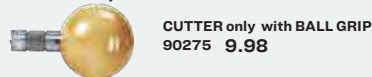

CUTTER only with BALL GRIP 90275 9.98

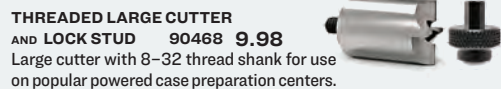

THREADED LARGE CUTTER AND LOCK STUD 90468 9.98
Large cutter with 8-32 thread shank for use on popular powered case preparation centers.



3 Jaw Chuck Trimming Kit

91720 29.00

Hex shank fits popular, low-cost cordless screwdrivers.
Universal 3 jaw chuck fits 25 ACP to largest belted magnums without changing shellholders.



Includes cutter and 3 jaw chuck.
Order cartridge specific case length gauge separately.

* Ackley Improved Cases use standard parent cartridge Case Length Gauge

	QUICK TRIM DIE 16.00	Ltd. Prod. QUICK TRIM DIE 20.00	CASE LENGTH GAUGE 8.00	Ltd. Prod. CASE LENGTH GAUGE 13.00
17 Fireball			91347	
17 Hornet	90611			
17 Rem		90435		
204 Ruger	90439			
218 Bee		91350		90225
219 Zipper				91305
22 Hornet	90354		90111	
*22/250	90284		90116	
220 Swift		91370	90118	
221 Fireball		91364	90112	
222 Rem Mag				91283
222 Remington	90340		90113	
*223 Remington	90179		90114	
223 WSSM		91358		90673
224 Valkyrie	90868		91339	
225 Winchester				91280
240 Weatherby Magnum				91281
243 Winchester	90320		90119	
243 WSSM		91341		90389
25 WSSM				90221
25-20 Winchester		91385		90121
25-35 Winchester				91306
25-06 Remington	90334		90124	
25-20 Winchester				90121
250 Savage (250/3000)		91374		90122
*257 Roberts		91357	90123	
257 Weatherby Magnum		91342	91298	
26 Nosler		90637		91307
260 Remington	90399		90993	
264 Winchester Magnum				91308
270 Weatherby Magnum				91279
270 Winchester	90229		90128	
6.8 Western		91761		
270 Winchester Short Mag	90393		90117	
28 Nosler				91284
280 REM ACK IMPROVED		91375		91295
6.5 Weatherby RPM		91771		
284 Winchester		91362		90129
30-378 Weatherby Magnum				91309
30-40 Krag		91354	90137	
30/06 Springfield	90291		90140	
*30/30 Winchester	90249		90136	
300 AAC Blackout	90689		90443	
300 H&H		90407		
300 H&H or Ultra Magnum			90141	
300 HAM'R		91609		
300 RSAUM		91343		
300 Remington Ultra Magnum		91366		
300 Savage		91356	90138	
300 Weatherby Magnum		90408	90143	
300 Winchester Magnum	90441		90142	
300 Winchester Short Mag	90484		90034	
303 British	90325		90144	
303 Savage		91383		

Trim brass to the correct length while chamfering the case mouth

QUICKTRIM

Lee Quick Trim Case Trimmer

The Deluxe Quick Trim Case Trimmer quickly and precisely trims your brass to the correct length at the same time it chamfers the inside and outside of the case mouth. No calipers, measurement or adjustment required. Simply install the appropriate quick trim die in your press and start trimming. A click adjustable stop allows trim length adjustment in .001 of an inch increments. Allows the user to shorten case to a uniform shorter length than standard, reducing trimming frequency. Includes snap on chip catcher. Order appropriate Quick Trim die for each cartridge listed on chart on upper right and opposite page. 90437 29.00



Chamfer Tool Must be used after Case Trimming. Unique design cuts fast without chatter. One turn does the job. Chamfers and deburrs inside and outside of case necks. Can also be used to remove the crimp from primer pockets of military brass. Works better than tools costing several times as much. 90109 3.98



Primer Pocket Cleaner Double ended design cleans both large and small primer pockets. Primers can be fully seated for better accuracy and safety. Costs so little and works so well, no reloader can afford to be without one. 90101 2.98



Case Conditioning Kit Includes cutter and lock stud, chamfer tool and primer pocket cleaner. 90950 12.98



Decapper & Base Easily removes crimped in primers from military cases. Guaranteed unbreakable.

22 Caliber 90103 30 Caliber 90102 7.98



The ultimate in case trimming, speed and convenience

Deluxe Power Quick Trim

Trim and chamfer in a matter of seconds. Hex shank snaps in to cordless screwdriver or drill (sold separately) Includes power Quick-Trim adapter, chip catcher and deluxe cutter assembly. To complete your trimming setup, order cartridge specific Quick Trim die from chart above and opposite page. 90670 27.00



Cordless screwdriver pictured is not included.



QUICK TRIM DIE	Ltd. Prod. QUICK TRIM DIE	CASE LENGTH GAUGE	Ltd. Prod. CASE LENGTH GAUGE
16.00	20.00	8.00	13.00

308 Marlin		91352	
308 Norma Magnum			91289
308 Winchester	90231		90139
32 Winchester Special			90491
32-40 Winchester		91376	91312
325 WSM		91344	90222
327 Federal Magnum			91303
338 Edge			91313
338 Federal			90218
338 Lapua			90462
338 Remington Ultra Magnum			91314
338 Winchester Magnum	90391		90149
340 Weatherby Magnum		91346	91223
348 Winchester		91360	91304
35 Remington	90403		90150
35 Whelen		91355	90972
350 Legend		91561	91567
350 Remington Magnum		91377	91315
358 Winchester			91318
358 WSSM		91378	
375 H&H	90395		
375 H&H or Ultra Mag			90164
375 Ruger		90613	91285
375 Socom			91319
375 Super Magnum			91320
375 Winchester		91371	90165
40-65 Winchester		91384	91323
416 Rigby			91324
416 Ruger			91294
43 Spanish			
444 Marlin		91367	
45/ 70 Government	90458	91372	90151
45/ 70 LEVERevolution			90152
450 Bushmaster			91325
450 Marlin			90554
458 Lott			91326
458 Socom			91290
458 Winchester Magnum		91345	90971
50 Beowulf			91292
50 BMG <small>REQUIRES LARGE CUTTER</small>			90010
			\$23.00
6.5 Carcano		91353	90043
6.5 Creedmoor	90812		90814
6.5 PRC		91348	91533
6MM ARC	91665		
6.5 Grendel	90763		91278
6.5 x 284		91361	
6.5 x 284 / 6.5 Rem Mag			90223
6.5 x 55 Swedish Mauser	90337		90126
6.5-06			91108
6.5 X 47 Lapua		91381	91330
6.5 X 50 Japanese			91331
6.5 X 57 Mauser			91291
6.8 SPC	90397		90189
6MM BR NOR/RE			91296
6mm Creedmoor	90658		91340
6MM PPC		91349	91282
6mm Remington (244 Rem.)		90434	90120
6MM TCU			91286
6MM XC			91328
6X45MM			91329
6X47 Lapua		91380	91302



QUICK TRIM DIE	Ltd. Prod. QUICK TRIM DIE	CASE LENGTH GAUGE	Ltd. Prod. CASE LENGTH GAUGE
16.00	20.00	8.00	13.00

* Ackley Improved Cases use standard parent cartridge Case Length Gauge

7 x 57 Mauser	90489		90130
7 x 64 Brenneke			90236
7-30 Waters			91335
7.35 Carcano			91293
7.5 x 55 Swiss (Schmidt-Rubin)	90419		90132
7.5 x 54 MAS		91359	90051
7.62 x 39 Russian	90345		90133
7.62 x 54 Russian	90342		90147
7.62 x 40 Wilson Tactical			91300
7.65 x 53 Mauser (Belgian-Arg)		91382	90134
7.7 x 58 Japanese Arisaka		91368	90115
*7mm Express/280 Rem.	90412		90166
7mm Remington Magnum	90297		90131
7MM RUM			91333
7MM STW			91332
7MM Weatherby Magnum			91334
7mm Winchester Short Mag			90314
7mm/08	90343		90167
7X64 Brenneke		91386	
8x56 Aust-Hung Mannlicher			90589
8x57 Mauser	90347		90148
8MM Remington Magnum			91337
8X68MM S			91288
9.3x62 Mauser	90614		91299
9.3x74 R			91301
22 TCM		91373	
5.7 x 28 FN		91363	90219
30 M1 Carbine	90365		90135
9mm Makarov	90181		90684
9mm Luger	90032		90153
357 SIG			91317
38 Super			90217
380 Auto	90025		90155
30 Herrett			91297
7.62X25 Tokarev			91336
32 ACP			91338
32 S&W			91311
32 Smith & Wesson Long			90169
32 H&R Magnum			91310
32-20 Winchester		91365	90146
38 S&W			90156
38 Special	90085		90157
38-40 Winchester		91351	91322
38-55 Winchester		91379	90994
357 Magnum	90088		90158
357 MAX			91316
40 S&W	90033		90154
10mm Auto	90193		90127
38 Short Colt			91321
41 Magnum		90226	90159
44-40 Winchester		91369	90168
44 Special	90107		90160
44 Magnum	90125		90161
45 ACP	90073		90162
45 Colt	90145		90163
45 GAP			91473
454 Casull		90174	90992
460 S&W			90220
480 Ruger <small>REQUIRES LARGE CUTTER</small>			90018
50 Action Express			91327
500 S&W <small>REQUIRES LARGE CUTTER</small>	90178		90019

UNLISTED RIFLE QUICK TRIM DIES can be custom made. leeprecision.com/custom-rifle-quick-trim-die-body.html

UNLISTED CASE LENGTH GAUGES can be custom made. leeprecision.com/custom-case-length-gauge.html

NEW

Ram Swage

Primer pocket swager works so fast that you'll want to swage all the range brass you pick-up. Works on all single stage presses with 7/8"-14 threads and accepts universal press shell holders. Features spring assisted case extraction, and an

all steel case guide, ensures cases will be positively centered on push rod. Shell holderless design, allows you to swage any small or large primer pocket, without swapping to a different size shell-holder.

91617 50.00

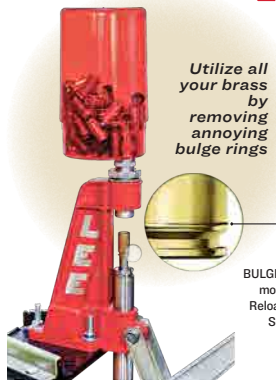

Utilize all your brass by removing annoying bulge rings

BULGE BUSTER KIT shown mounted to Breech Lock Reloader Press (90045). Sold separately, pg. 18

LEE BULGE BUSTER

Assure your mixed brass is bulge free with the Bulge Buster Kit and appropriate Lee Carbide Factory Crimp Die. This push through die adapter will quickly remove the annoying bulge rings that shell holder constrained dies simply can't reach. The Bulge Buster Kit includes extension sleeve, push through punch, catch container and complete instructions. And it's fast — you can reprocess your cases as quickly as you can handle them. CARBIDE FACTORY CRIMP DIES, SEE PAGE 7

Bulge Buster Kit 90487 19.98

- 90867 380 ACP
- 90862 10 mm
- 90862 40 S&W
- 90416 41 AE
- 90864 45 ACP
- 90864 45 GAP
- 90864 45 Win Mag

WITH THE LEE FACTORY CRIMP DIE, THE BULGE BUSTER WILL REPAIR ALL THESE RIMLESS CASES

Catch Container



Push through Punch Extension Sleeve

NEW

SHOWN WITH
UNIVERSAL CASE FEED MAGAZINE
Sold separately #90242

ACP

AUTOMATIC CASE PRIMER

METALLIC CARTRIDGE PRIMING

was revolutionized in 1979 with Richard Lee's patented **AUTO PRIME** tool. Today, the majority all hand-held priming tools share most, if not all, features of the Original Auto-Prime. The new ACP truly automates priming. Think of it as the "REAL" AUTO-PRIME. This is the nicest priming tool ever made. No shell holders required; cases are guided into position by our new "finger guide" – priming is positive, effortless and uniform. Positive and consistent seating depth is assured with our new dead length priming device. Primers are seated uniformly without "feel" or adjustments required. Seating is almost effortless as the priming tool shares the powerful linkage of our Automatic Processing Press. And the best feature is the ability to automatically feed cases! Nothing else to buy – will seat large and small rifle and pistol primers. Automatically feeds and primes cases up to 2½ inches long.

ACP - AUTOMATIC CASE PRIMER

91610 140.00

Pictured with CASE COLLATOR #90667
Sold separately pg. 23

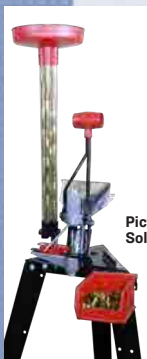

Depriming Kit

Use your ACP as the world's fastest, shellholderless deprimer. Great for those who tumble clean cases before reloading. Includes screw top catch bottle for spent primers and debris.

91714 12.00

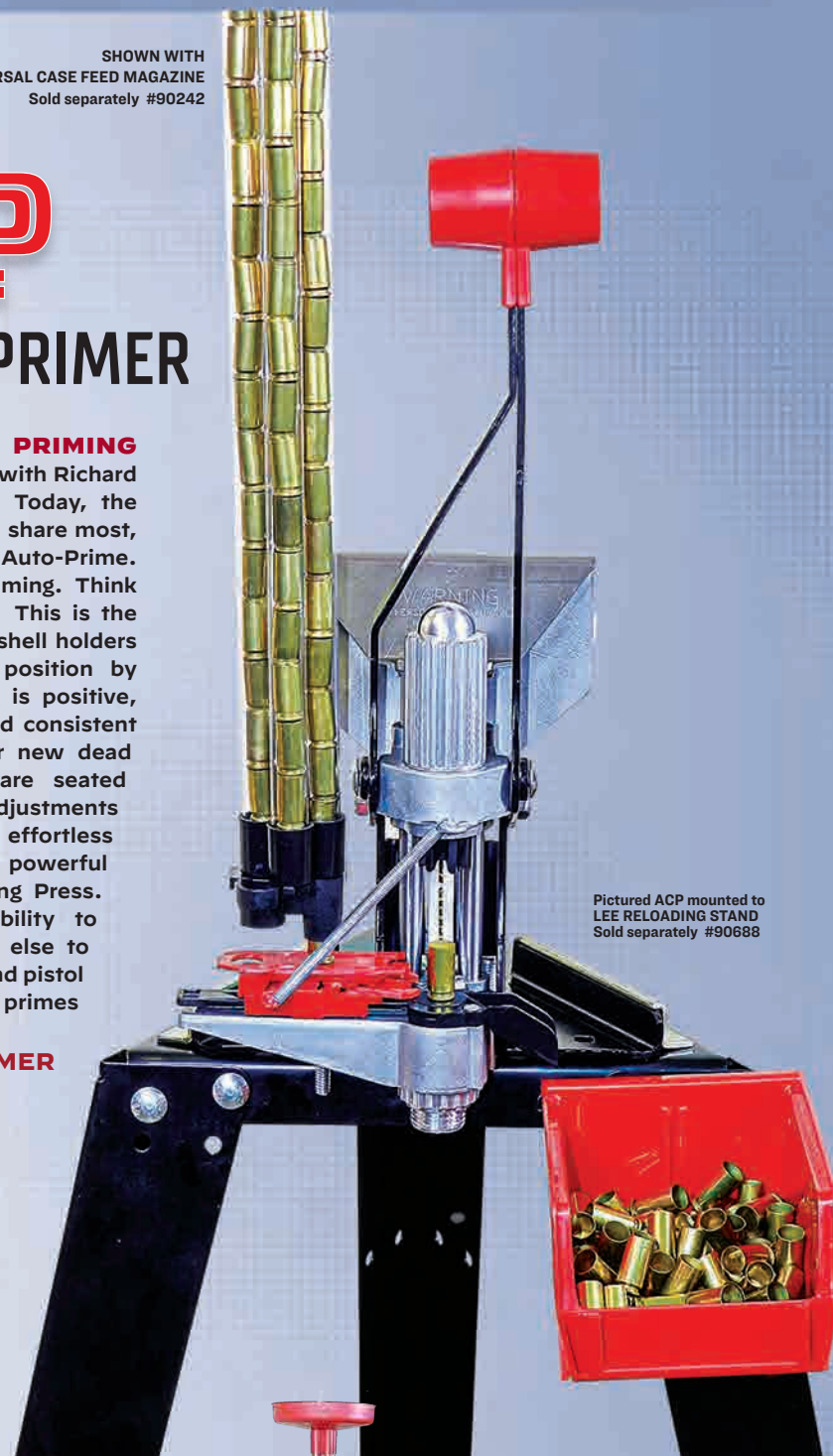

Pictured ACP mounted to
LEE RELOADING STAND
Sold separately #90688

**THE NEXT REVOLUTION
IN PRIMING.
THE WORLD'S FIRST
AUTOMATICALLY
CASE FED,
SHELL HOLDER-LESS
PRIMING TOOL**



OFF PRESS PRIMING

AUTO BENCH PRIME

THE EASIEST, MOST CONVENIENT BENCH MOUNTED PRIMING tool ever. Symmetrical design allows effortless right or left hand operation. Comfortable lever with just the right amount of mechanical advantage effortlessly seats even the most difficult primers with just finger pressure. Perfect mechanical advantage to feel the primer seating completely home into the primer pocket.

Includes priming assemblies for large and small primers. Change primer size or shell holder in seconds.

Includes the patented folding tray — go from box to priming in seconds. No need for a heavy bench; fits the Lee Bench Plate or mount to a board for a portable setup.



Tray's built-in flipping surface quickly rights and orients primers — go from box to priming in seconds. Patented elevator pin safely isolates a single primer for priming. Allows most primer brands and types to be safely tray fed. The convenient hinged cover allows you to individually feed primers if restricted by the primer manufacturer.

Auto Bench Prime
90700 **43.98**



Folding Primer Tray
TWO PACK 90606 **8.00**

New, removable tray PATENTED



Unfold tray and place on top of box of 100 primers. Flip tray over to deposit the primers. Shake tray to upright all the primers. Fold and close cover. Slide the flow control to LOCK.



Packed in a lifetime plastic box

Set of Shellholders

Eleven of the most popular sizes fit over 115 different cartridges. The chart (below) is included with each shell holder set.

Additional cartridge listings on leeprecision.com

1 · 2 · 3 · 4 · 5 · 7 · 8 · 9 · 10 · 11 · 19

RED STORAGE BOX ONLY 90196 **4.98**
SHELL HOLDER SET 90198 **25.98**
with 11 Shellholders for LEE PRIMING TOOLS AND THESE OTHER FINE TOOLS — K&M, SINCLAIR, F A PLATINUM, CPS, 21ST CENTURY

ALL OFF-PRESS PRIMING TOOLS USE SPECIAL, BUT INEXPENSIVE PRIMING TOOL SHELL HOLDERS, SO THERE'S NO NEED TO ENDLESSLY SWAP PRESS SHELL HOLDERS TO PRIME.

HOLDER	RIFLE	HOLDER	RIFLE	HOLDER	RIFLE	HOLDER	RIFLE	HOLDER	PISTOL
20	17 Hornet	2	250 Savage	12	7.62mm x 39	2	35 Remington	7	32 ACP
4	17 Remington	3	25/35	16	7.62x54 Russian	5	35 Winchester	4	32 Colt N.P.
4	204 Ruger	4	25/45 Sharps	3	30 Herrett	2	35 Whelen	4	380 Auto
#6	90206	4	22 TCM	2	257 Roberts	3	30/30 Win. (30 WCF)	5	9mm LUGER
#7	90207	20	22 Hornet	5	257 Weatherby	2	300 Savage	3	356 Winchester
#8	90208	20	22 K Hornet	2	6mm Creedmoor	16	30/378	2	358 Winchester
#9	90209	3	22 Savage	2	6.5mm Creedmoor	21	30 Remington	5	358 Norma Magnum
#10	90210	10	22 BR	2	6.5mm 06	2	308 Win. (7.62 NATO)	3	375 Winchester
#11	90211	6	218 Bee	2	6.5mm x 57	4	300 AAC Blackout	5	375 H & H
#12	90212	12	22 PPC	3	6.5 x 55 Mauser	5	30/40 Krag (30 U.S.)	5	375 Weatherby
#13	90213	3	219 Zipper	10	6.5 Jap	2	30/06 Springfield	5	375 Ultra Magnum
#14	90214	3	220 Swift	5	6.5 Rem. Magnum	5	300 H & H	5	375 Ruger
#15	90017	4	221 Fireball	2	6.5 Carcano	5	300 Weatherby	14	38/40 Win.
#16	90200	4	222 Remington	12	6.5 Grendel	5	300 Win. Magnum	3	38/55 Winchester
#17	N/A	4	222 Rem. Magnum	5	264 Win. Magnum	5	300 Ultra Magnum	8	40/82 Winchester
#18	N/A	4	223 (5.56mm)	5	26 Nosler	5	300 Win S Magnum	5	416 Remington
#19	90023	5	223 WSSM	21	6.8 SPC	5	308 Norma Magnum	25	416 Rigby
#20	90020	2	224 Clark (22/257)	2	270 Winchester	5	303 British	18	43 Mauser
#21	90031	21	224 Valkyrie	5	270 Weatherby	2	7.7 Japanese	17	43 Spanish
#24	91495	10	225 Winchester	5	270 Win S Mag	3	32 Win. Spc'l	14	44/40
#25	91496	2	22/250	2	280 Remington	3	32 Win. S.L.	11	444 Marlin
		2	240 Weatherby	2	7mm/08	6	32/20 (32 W.C.F.)	8	45/70 Gov't
		2	243 Win.	3	7mm BR	3	32/40 Winchester	2	450 Bushmaster
		5	243 WSSM	4	7mm TCU	2	8 x 57 Mauser	5	458 Win. Magnum
		2	6mm Remington	3	7 x 30 Waters	2	8mm 06		
		2	244 Remington	2 & 10	7 x 57mm Mauser	2	8mm Man. Schoe.	HOLDER	PISTOL
		2	6mm Int'l	5	7 x 61 Sharpe & Hart	5	8mm Rem. Magnum	15	5.7 x 28
		2	6mm/284	5	7mm Rem. Magnum	17	8mm Lebel	1	22 Rem. Jet
		2	6mm/06	5	7mm Win S Mag	16	8x56R Hungarian	15	25 ACP
		12	6 PPC	5	7mm Weatherby	8	33 Winchester	1	256 Win. Magnum
		4	6 x 47 (6mm/222M)	5	7mm Ultra Mag	25	338 Lapua	19	30 Luger
		2	25/284	2	284 Winchester	5	338 Win. Magnum	19	30 Mauser
		5	25/303	3	7.5mm Schmidt-Rubin	5	338 Ultra Magnum	4	32 Short Colt
		2	25/06	7	30 M 1 Carbine	5	340 Weatherby	4	32 Long Colt
		6	25/20 Winchester	3	7.65x53 Arg. Mauser	8	348 Win.	4	32 S & W
								4	32 S & W Long
									11 & 14
									45 Colt
									45 Schofield
									1.1
									454 Casull
									14
									460 S&W
									5
									455 Webley
									13
									45 Auto Rim
									3
									45 Win. Magnum
									5 & 16
									480 Ruger
									5
									475 Linebaugh
									16
									500 S&W

New Auto-Prime

The original and world's most popular hand-held priming tool. Fast and economical hand held priming with unmatched feel and accuracy. Comes packed in a convenient storage box to keep your tool and shell holders together.

90230 **31.98**



Save even more! Purchase a kit!

Priming Tool Kit

Includes the New Auto-Prime, and nice molded storage box. Holds everything, including a complete set of shell holders. This kit comes with 8 of the most popular priming tool shell holders, works with over 130 different cartridges. 1, 2, 3, 4, 5, 11, 12, 19. Holds an additional 8 shell holders. This kit is a convenient way to keep your tool and shell holders all in one spot.

90215 **47.98**



Priming Tool Storage Box

Holds your New Auto Prime tool. With room for 18 priming tool shell holders. 90426 **5.98**

INCLUDES THE NEW POWDER MEASURE BOTTLE ADAPTER

DELUXE PERFECT POWDER MEASURE

QUALITY CONSTRUCTION

This powder measure features a high pressure die cast, diamond-machined body. The precision-machined rotor drum is cast from brass, which is naturally anti-static and spark proof.

ELIMINATES CUT POWDER AND JERKY ACTION

A soft elastomer wiper strikes off the metering chamber rather than cut the powder. You'll be surprised at how smoothly the rotor operates. More importantly, you will enjoy the most uniform of charges.

EASY TO SET & READ MICROMETER METERING CHAMBER

Powder charge adjustment is accomplished with a true micrometer adjustable metering chamber. The metering chamber is aluminum with a black anodized finish. Features a crisp, permanent, laser engraved scale. The brass micrometer thimble is engraved with .01cc graduations and has a releasable detent lock. With most rifle powders each click is about a 1/10 of a grain, perfect for working up a load.

CHANGING POWDER IS FAST AND EASY

Features easily removable hopper with an on/off valve so you can quickly return unused powder to its original container or switch to another type. The hopper feeds to a pre-measuring chamber allowing precise charges regardless of the powder level in the hopper, eliminates the need for an extra powder baffle.

QUICK CHANGE DRUMS

One of the nicest features is the ability to use the new Lee standard quick-change drums (product # 90453). These low cost drums can be preset to your favorite charge and swapped out in seconds.

DELUXE PERFECT POWDER MEASURE 90699 90.00



PICTURED ON OPTIONAL STAND # 90587, SOLD SEPARATELY

NO POWDER MEASURE, REGARDLESS OF PRICE, HAS ALL THE FEATURES OF THE LEE DELUXE POWDER MEASURE

PERFECT FOR USE WITH THE DELUXE PERFECT POWDER MEASURE & AUTO-DRUM



QUICK CHANGE DRUM SET features four precision molded nylon drums. Two small capacity for cases as small as the 25 ACP, adjustable to 223 size rifle cases. Large capacity drums adjustable from 223 case to cases as large as the belted magnums. The large drums include an insert to allow reduced capacity charging like the small drum. All drums are infinitely adjustable within range. No tools required for adjustment. A graduated adjustment key is included with each drum. Each key is marked with .01cc graduations, allowing easy 1/10-grain powder adjustments.

Quick Change Drum Set 90453 20.00

POWDER MEASURE BOTTLE ADAPTER

POWDER MEASURE BOTTLE ADAPTER FITS ALL LEE POWDER MEASURES



Allows dispensing powder directly from the shipping container of most popular powder manufactures. Includes a crystal clear bottle that holds over a half a pound of ball powder. Works on all of these and many more.

(53mm or 43mm thread)

Dispensing powder directly from the bottle assures positive identification of the powder type.

Adapter is manufactured from



Polypropylene —resistant to attack from all

types of powder. Now you can turn off the powder flow and store your powder in its original container with no fear of misidentifying or damage to your hopper from chemical attack. Viewing window allows monitoring powder level in use without removing bottle.

Bottle Adapter 91586 8.00

Powder Measure Stand

Heavy, powder coated steel construction

7/8" mounting hole for all popular measures

Includes 3 no slip feet

Rock solid mount improves measure consistency

Space saving freestanding design is portable and convenient.

Works with other brands of powder measures

Powder Measure Stand 90587 45.00



Lee Safety Scale

Safety and accuracy are the most important features

This is the only scale that can never get out of adjustment. The beam is made from a very tough phenolic, the same type material used on table and counter tops. Phenolic is tough but, like glass, it can't be bent. Even if dropped you can feel confident that if it did not break it is still accurate. Sensitive and readable to 1/20 grain.

90681 46.98

READ THIS if you already have a combination bullet and powder scale

Try this simple test to see how sensitive your scale really is. Cut a piece of regular writing paper or this catalog 5/16 inch square. With scale set on zero — drop the paper on the pan to see if it moves. It should read about .1 grain. Keep adding paper squares until it does move. The total number of squares needed to move your scale is your scale's sensitivity. We have seen digital powder scales that are only sensitive to 1/2 grain (FIVE paper squares!) A Lee Safety Scale will move with the first paper.



Lee Powder Measure Kit

Fifteen uniformly graduated and proportioned powder dippers. Slide card shows the grains of powder each measure will dispense of every type of powder. Powder measures are inherently safe as they cannot get out of adjustment. That's why powder dippers continue to be the first choice of reloaders who load in small quantities.

90100 14.98

Powder Funnel

A large, unbreakable funnel that fits all cases from .22 to .45 caliber. Hole in flange permits mounting to the Lee Turret Press, shelf or bench.

90190 4.98



INCLUDES THE NEW POWDER MEASURE BOTTLE ADAPTER

The Original Perfect Powder Measure

Almost as good as a scale!

Solves problems common to ordinary drum type measures. Gives you the confidence that your charges will be the most uniform possible.

Lee Perfect Powder Measure

Includes many of the features of the Deluxe Perfect Powder Measure, but the body is molded from an engineering grade polymer. Rotating micrometer adjustable metering chamber and elastomer wiper to prevent powder cutting. Works better than other powder measures priced four times as much.

90058 30.98



FREE STURDY STEEL MOUNTING BRACKET INCLUDED WITH EACH MEASURE

CHARGE CASES WHILE EXPANDING THE CASE MOUTH

AUTO DRUM

Automatic case actuated drum powder measure. Accurately and automatically dispense powder in your favorite cartridge. Two infinitely adjustable drums included. Quick Change drums will accurately and reliably drop charges from 1 to 80 grains of powder.



"MODERN RELOADING" AND ALL POPULAR LEE DIE SETS INCLUDE LOAD DATA

Lee Pro Auto-Disk Powder Measure

Commercial reloaders or competitive shooters first choice! Elastomer wiper and polytetrafluoroethylene (PTFE) non-stick metal casting make this the smoothest operating measure. Large hopper with integral shut-off valve makes changing powder or disks super convenient. Brass thumbnuts attach the hopper to the body so you can change disks with no tools. Rubber wiper and seal prevents powder shearing and makes it more leak-resistant with fine-grain powders. Increased safety with positive pull-back lever.

The measure is attached to the die with a swivel adapter, allowing easy positioning and quick removal when changing cartridges. Included positive pull back lever reduces the chance of double charge when progressive reloading.

Lee Pro Auto-Disk Powder Measure INCLUDES ALL FOUR DISKS 90429 60.00



INCLUDES THE NEW POWDER MEASURE BOTTLE ADAPTER

Case actuated; never spill a charge.

Exclusive elastomer wiper prevents powder shearing, works great with difficult metering extruded powders.

Machined body with labyrinth groove mates to precision molded nylon drums providing leak free fit with the finest powders.

Drum is actuated by a steel sector and pinion gear train.

Quick-change hopper has on/off valve Sleek modern design, all gears springs and levers inside the die cast housing.

Same swivel adapter as our famous Pro Auto-Disk powder measure. Makes moving measure fast and convenient.

HANDGUN AND RIFLE DRUMS INCLUDED.

AUTO-DRUM POWDER MEASURE 90811 55.00



PRO AUTO-DISK POWDER MEASURE	
CARTRIDGE RANGE	9 MM TO 45 COLT
USE	IDEAL FOR HANDGUN
SIMPLE SET UP	NOTHING TO ADJUST, NOTHING TO GET OUT OF ADJUSTMENT USE LEE PUBLISHED LOAD DATA
CONSISTENCY	EXTREMELY CONSISTENT INCREMENTAL CHARGES
WIPER TO PREVENT POWDER SHEARING	YES
SWIVEL ADAPTER FOR FAST, EASY TRANSFER	YES
ON/OFF VALVE	YES

AUTO-DRUM POWDER MEASURE	
CARTRIDGE RANGE	25 AUTO TO 300 WIN MAG
USE	IDEAL FOR BOTH HANDGUN AND RIFLE
ADJUSTABILITY	INFINITELY ADJUSTABLE WITH INCLUDED SMALL AND LARGE QUICK CHANGE DRUMS
CONSISTENCY	EXTREMELY CONSISTENT .01 CC INCREMENTAL CHARGE ADJUSTMENT
WIPER TO PREVENT POWDER SHEARING	YES
SWIVEL ADAPTER FOR FAST, EASY TRANSFER	YES
ON/OFF VALVE	YES

The Pro Auto-Disk comes with a complete set of four disks. Each disk has six cavities, so you get 24 cavities in all. The chart included on the rear of the instruction sheet lists the capacity of each cavity with every type of powder. If you reduce your charge 10% you can safely use this data without weighing your charge. Fixed cavities are the safest way to meter powder because they can't be misadjusted or get out of adjustment.

PRO AUTO-DISK ACCESORIES



Adjustable Charge Bar

Infinitely adjustable between .28 and 1.6 cc. Lifetime nylon with solid brass, zero backlash micrometer. Easy to set.

Adjustable Charge Bar 90792 9.98

Double Disk Kit (not pictured)

This kit raises the hopper so you can stack two disks. Not only doubles the capacity of the disks but it makes very fine adjustments possible. Most powders can be adjusted up or down .1 grain with different combinations of disks. Complete listing of combinations, 4 extra disks, screws and risers are included.

Lee Double Disk Kit 90195 14.98

Lee Rifle Charging Die Kit

Short and Long Charging Dies are included. These dies work the same as the pistol powder through expanding dies, except they do not expand the case mouth. Rifle case expansion is done in the sizing die. Can be used on 22 caliber, and up to the largest belted magnums.

Charging Die kit 90995 28.00

SHORT CHARGING DIE 22 HORNET TO 223 REM 90668 15.98

LONG CHARGING DIE 223 REM TO 300 WIN MAG 90194 15.98

Powder Measure Riser

Installs between the Lee Powder through Expanding Die or Rifle Charging Die and Powder Measure. Allows convenient use of other brands of dies that have extended adjusting screws and provides clearance for the Lee Safety Prime.

Powder Measure Riser 90041 9.98

POWDER THROUGH EXPANDING DIE pg. 8

NOTE Pro Auto-Disk and Auto-Drum Powder Measures must be used with the powder through expanding die supplied with all Lee pistol dies, or Lee Rifle Charging Dies (see left). These dies may be purchased individually. Sizes listed on page 8.

Only Lee Dies permit charging the case while expanding the case mouth.

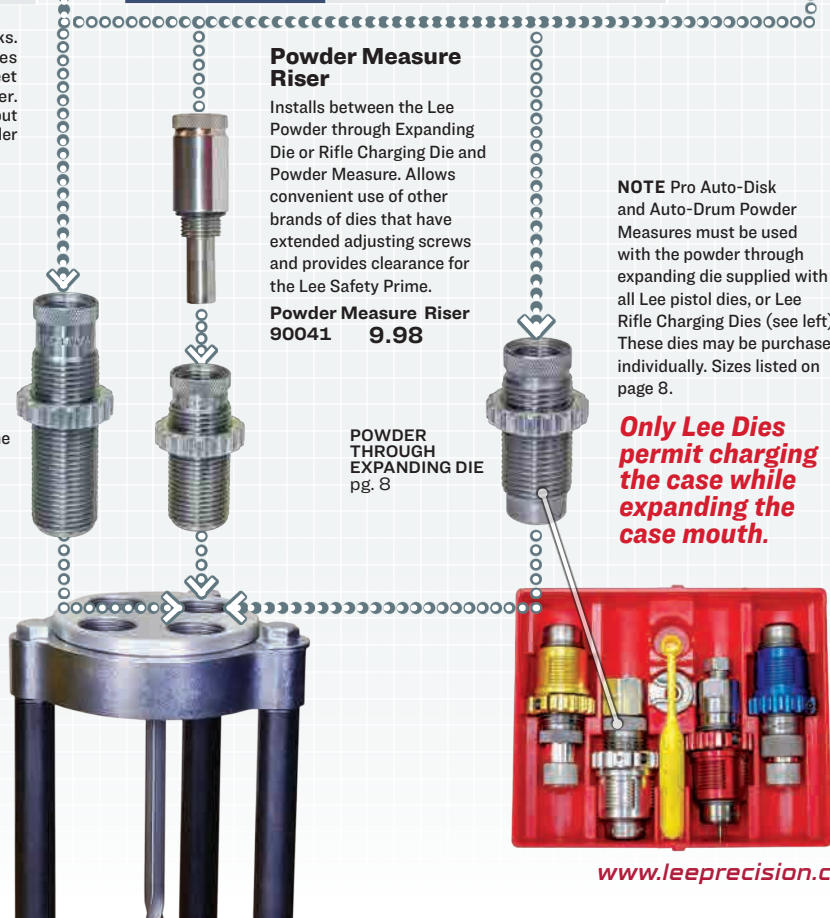



Lee Pro 4-20

Large diameter high capacity pot, holds approximately 20 pounds of lead. Nearly 4 inches of clearance under the spout accepts all brands of bullet molds and most sinker molds. It also includes an adjustable mold guide to quickly and accurately position any mold for pouring.

This second generation design incorporates the famous Lee patented high-efficiency design and dependable remote sensing thermostat, in a dust tight housing. Long life 700-watt tubular heating element assures quick melting and rapid recovery. Micro adjustable, flow control valve adjusts instantly with a twist of the screwdriver. Front mounted low maintenance replaceable valve spout allows instant reseating with a turn of a screwdriver.

LEE PRO 4-20	90947	110 Volt	115.00
EXPORT MODEL	90948	220 Volt	123.00



Lee Precision Melter

High speed melter with an infinite heat control for the budget caster. Easily handles 4-cavity molds. Takes less than 15 minutes to melt 4 pounds of metal. Same infinite heat control as used on the Production Pot. 500 watts AC only. Guaranteed 2 years.

PRECISION MELTER, 110V	90021	64.98
EXPORT MODEL, 220V	90024	67.98

LEE MOLD MALLET

Features ash hardwood construction. Cut the sprue and release the bullets with one handy tool. Ergonomic design makes it convenient and comfortable to use with long casting sessions. Mallet is 10 inches long.

90084 **10.00**



UNIQUE INFINITE HEAT CONTROL

A highly reliable control, mounted away from the high heat of the pot. Eliminates failures usually associated with thermostatically controlled units. Thermal feed back to the infinite control permits heater to put out full power until metal has melted.



Magnum Melter

Large 4" diameter pot allows easy access for the ladle caster. Same high efficiency design that has made Lee pots the most popular. Melt time is less than 20 minutes with just 700 watts. 20-lb. capacity for the longest casting session.

Magnum Melter	110 Volt	90949	89.00
----------------------	-----------------	--------------	--------------

LEE MAKES BULLET CASTING EASIER

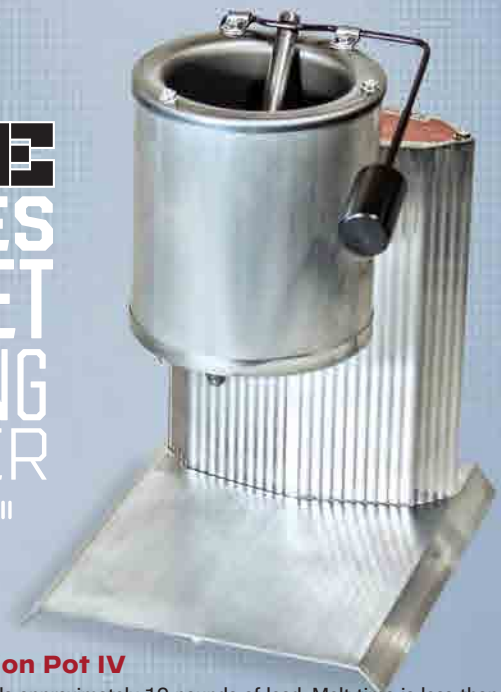

Lee Production Pot IV

Large, deep pot holds approximately 10 pounds of lead. Melt time is less than 20 minutes. Pour spout up front where it belongs so you can see what you're doing. Infinite heat control. Uses only 500 watts of power during heat-up and a lot less to maintain temperature. Large, stable base for safety. 4" of clearance under the spout is high enough to accept all brands of bullet molds and most sinker molds.

PRODUCTION POT IV	110 VOLT	90009	99.98
EXPORT MODEL	220 VOLT	90008	104.98

LEE INGOT MOLD

Use to cast 1/2 and one pound ingots. Perfect for remelting and alloying. Wood handles stay cool. Aluminum mold is lightweight and rustproof.

90029 **20.98**

LEE LEAD LADLE

A convenient size ladle for bullet casting. Works equally well for right and left handers. Handy for skimming and stirring metal.

90026 **6.98**



WARNING Melting lead and casting lead objects will expose you and others in the area to lead, which is known to the State of California to cause reproductive harm and cancer. For more information, www.P65Warnings.ca.gov. See instructions on REDUCING EXPOSURE supplied with product.

BREACH LOCK BULLET SIZER KIT

FASTEST AND EASIEST WAY TO SIZE CAST BULLETS

Breach Lock Bullet Sizer Kit works in any Breach Lock Press. Uses inexpensive bullet sizer and punch, see listing right. >

The quick change body accepts our new, low cost bullet sizer and punch. The new sizer is produced of high carbon steel, and specially tapered to reduce sizing effort.

Bullets are sized nose first—this is the most accurate and causes the least distortion.

Best of all, no special top punches are required. Will seat and crimp gas checks while sizing.

Great for powder coated or liquid lubricated bullets. All bullets must be lubricated, order Lee Liquid Alox or your favorite coating. Order appropriate bullet sizer and punch, see listings at right.

Breach Lock Bullet Sizing Kit
91532 15.00



GET INCREDIBLY FAST BULLET SIZING with the LEE APP

See pg. 27



RELOADER PRESS shown with optional bottle adapter →

91151 6.00

Includes bottle that holds 100 bullets. Adapter also fits most powder containers for larger capacity.

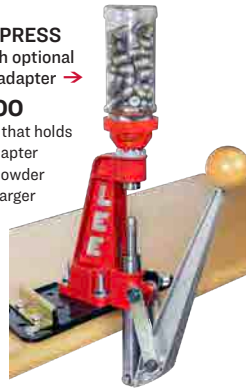

ORDER BULLET SIZER AND PUNCH RIGHT >

Bullet Sizer and Punch 12.00



Other sizes can be made on a custom basis. See web for details. leeprecision.com/custom-breach-lock-bullet-sizer-punch/

BULLET DIAMETER	BULLET SIZER & PUNCH 12.00	CLASSIC BULLET SIZING KIT 25.98
.224	91505	90049
.225	91506	90036
.243	91507	90083
.278	91508	90261
.284	91509	90170
.285	91510	90171
.308	91511	90037
.309	91512	90038
.311	91513	90039
.314	91514	90044
.323	91515	90686
.329	91516	90934
.339	91517	90576
.356	91518	90046
.357	91519	90047
.358	91520	90048
.401	91521	90060
.410	91522	90052
.427	91523	90053
.429	91524	90054
.430	91525	90062
.451	91526	90061
.452	91527	90055
.454	91528	90056
.457	91529	90057
.458	91591	91682
.459	91616	91672
.460	91592	91829
.501	91530	90191
.510	91531	90188

Classic Bullet Sizing Kit

Standard 7/8 x 14 threads fit any reloading press.

Bullets are pushed through the sizing die nose first, so no special nose punches are needed. Gas checks are automatically seated and crimped in place. Sized bullets captured in the special container. COMPLETE FOR ONE SIZE 25.98

BULLETS MUST BE LUBRICATED FOR SIZING. ORDER LEE LIQUID ALOX BELOW

GOOD FOR THOUSANDS OF BULLETS.

Other sizes can be made on a custom basis. See web for details.

leeprecision.com/custom-lube-and-sizing-kit.html

(PRESS NOT INCLUDED)



LUBRICATING BULLETS

Try this with your bullet lubricant



The bullet melts while the Lee Liquid Alox clings tenaciously to the bullet

Lee Liquid Alox

Enough for thousands of bullets

Lee Liquid Alox gives better accuracy because it eliminates leading. The lube coats the entire bullet like a thin jacket and dries to a soft, varnish-like finish that really clings. The dried coating does not degrade gunpowder. Easy to apply; eliminates the need for sizing of most cast bullets. While it works well with all cast or swaged bullets better than any other lube, it works most economically with micro band bullets, which are designed for tumble lubing.

4 OZ. DISPENSER BOTTLE 90177

6.98

Traditional bullet lubricating methods of placing lube only in the grooves are inferior to the modern method of coating the entire bullet with Lee Liquid Alox. This places the lube where needed, on the surfaces that rub against the bore.



Gently shake bullets in an orbital motion to coat the bullets. If they do not coat completely, add a little more lube.



Spread bullets onto waxed paper and let dry overnight.



Universal Case Expanding Die

Gently flares the case mouth to accept cast bullets without shaving. Works great to prevent damaging the moly and low friction coatings found on today's high performance jacketed bullets. Includes neck plugs for .22 cal through .45 cal. Works on everything from the 22 Hornet to the largest Ultra Mag. Costs so little and works so well you can't afford to be without one.

90798 18.00

Hardness Testing Kit

Featured product in Chapter 10 "Modern Reloading." No more wasted components shooting too soft or too hard lead. Cast and load with confidence knowing your alloy is up to the job. Quickly and precisely check hardness of your lead alloy. Exclusive conversion chart tells the maximum operating pressure of any lead alloy.

90924 99.00

INCLUDES

CALIBRATED HARDENED STEEL BALL INDENTER
V" BLOCK CRADLE SNAPS INTO STANDARD PRESS RAM
20 POWER 4 LENS OPTICAL MEASURING MICROSCOPE



LEE MOLDS FEATURE
TROCHOIDAL VENTING

Unique venting on the mold face and sprue plate mating surface allows consistent and effortless fill out.



PISTOL BULLET MOLDS

32/20 · 32S&W LONG · 32 COLT NP

38 SPECIAL · 38 S & W · 38 COLT NEW POLICE · 357 MAG

	.125	.174	.100	.106	.116	.142	.072	.072	.131	.117	.117	.207	.160
BALLISTIC COEFFICIENT MOLD	311-93-1R	311-100-2R	TL314-90-SWC	358-105-SWC	358-125-RF	358-140-SWC	TL358-148-WC	358-148-WC	358-150-1R	TL358-158-SWC	C358-158-SWC	TL358-158-2R	358-158-RF
DOUBLE	90300	90301	90311	90316	90574	90318	90279	90312	90328	90321	90322	90388	90303
6 CAVITY	90308			90315	90306	90317	90294	90380	90326	90295	90327	90319	90692
LUBE&SIZE	90039	90039	90044	90048	90048	90048	90048	90048	90048	90048	90048	90048	90048
BL BULLET SIZER	91513	91513	91514	91520	91520	91520	91520	91520	91520	91520	91520	91520	91520

9MM LUGER · 38 SUPER AUTO · 380 AUTO

9mm MAKAROV

40 S&W · 10 MM AUTO

41 MAGNUM

44 SPEC · 44 MAG · 44/40

	.107	.105	.123	.164	.127	.166	.093	.117	.141	.141	.110	.119	.111	.124
BALLISTIC COEFFICIENT MOLD	TL356-95-RF	356-102-1R	356-120-TC	TL356-124-2R	TL356-124-TC	356-125-2R	365-95-1R	401-145-SWC	TL401-175-WC	401-175-TC	410-195-SWC	TL410-210-SWC	429-214-SWC	C429-240-SWC
DOUBLE	90601	90305	90239	90464	90238	90309	90466	90470	90431	90256	90330	90335	90336	90338
6 CAVITY	90672		90387	90465	90402	90457			90433	90690				90483
LUBE&SIZE	90046	90046	90046	90046	90046	90046	custom	90060	90060	90060	90052	90052	90054	90054
BL BULLET SIZER	91518	91518	91518	91518	91518	91518	custom	91521	91521	91521	91522	91522	91524	91524

44 SPECIAL · 44 MAGNUM · 44/40

45 ACP · 45 AUTO RIM · 45 COLT

	.124	.196	.169	.218	.090	.127	.140	.127	.145	.189	.146	.146
BALLISTIC COEFFICIENT MOLD	429-200-RF	429-240-2R	TL430-240-SWC	C430-310-RF	452-160-RF	452-200-SWC	452-200-RF	TL452-200-SWC	452-228-1R	TL452-230-2R	TL452-230-TC	452-230-TC
DOUBLE	90285	90341	90299	90858	90570	90348	90234	90463	90351	90346	90287	90290
6 CAVITY	90428	90339	90357	90227		90310	90697	90379	90352	90350	90286	90289
LUBE&SIZE	90054	90054	90062	90062	90055	90055	90055	90055	90055	90055	90055	90055
BL BULLET SIZER	91524	91524	91525	91525	91527	91527	91527	91527	91527	91527	91527	91527

45 ACP 45 AUTO RIM 45 COLT

45 COLT 45A CASULL

475 LINEBAUGH

500 S&W

	.136	.210	.233	.271	.296
BALLISTIC COEFFICIENT MOLD	452-252-SWC	452-255-RF	C452-300-RF	476-400-RF	C501-440-RF
DOUBLE	90356	90358	90359	90241	90991
6 CAVITY		90349	90228		
LUBE&SIZE	90055	90055	90055	custom	90191
BL BULLET SIZER	91527	91527	91527	custom	91530

CUSTOM MOLDS We can produce custom bullet molds within certain limits. The prices are the same as our standard molds, but there is a tooling and set-up charge. If interested in this service, please access design assistance sheet on www.leeprecision.com. This outlines the basic limitations of our manufacturing process.

<https://leeprecision.com/files/instruct/MoldDesignAssistance.pdf>



WARNING Melting lead and casting lead objects will expose you and others in the area to lead, which is known to the State of California to cause reproductive harm and cancer. For more information, www.P65Warnings.ca.gov. See instructions on REDUCING EXPOSURE supplied with product.

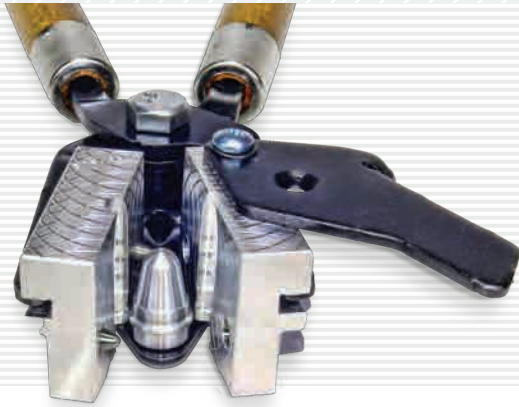

Cast Minie Bullets as fast as Round Balls

Minie Bullet Mold

Automatic Core Pin Mold. Open mold upside down to empty. Close it and you're ready to cast the next. The core pin automatically centers in the mold. Easily cast 200 per hour. A quality mold built to last as long as your rifle.

COMPLETE w/ HANDLES and AUTOMATIC CORE PIN 50.98



Round Ball Molds

Have tangential cut off which eliminates the objectional nib at the sprue.

DOUBLE CAVITY WITH HANDLES 39.98
6-CAVITY WITHOUT HANDLES 64.00

SIZE	DOUBLE	SIZE	DOUBLE	SIZE	DOUBLE
.311	90406	.440	90436	.535	90456
.319	90410	.445	90438	.562	90460
.350	90415	.451	90440	.575	90461
.360	90418	.454	90442	.600	90975
.375	90420	.457	90444	SIZE	SINGLE
.380	90423	.490	90448	.690	90978*
.390	90424	.495	90450	<small>*Due to the diameter, mold ships as a single cavity.</small>	
.395	90425	.500	90452	SIZE	6 CAVITY
.433	90432	.530	90283	.490	91711▲

▲ Handles #90005 26.98



Improved Minie, Traditional Design

45 Cal.	.450-294M	90467
45 Cal. oversize	.454-298M	90469
50 Cal.	.500-360M	90472
54 Cal.	.533-410M	90473
54 Cal. oversize	.540-415M	90474
58 cal.	.575-472M	90476
58 cal. oversize	.578-478M	90478

Improved design is easier to cast and load. Usually more accurate; a wider variety of sizes.



Modern Minie, Target Design

50 Cal.	.500-354M	90471
---------	-----------	-------

The most accurate of all Minies. Makes nice, clean holes in the target. The first choice for highest scores.



Original Style Minie Bullet

58 Caliber	575-500M	90481
------------	----------	-------

An extremely popular, traditional size Minie bullet. Available in 58 caliber only. Certainly a must for authentic muzzle loading shooting.



RIFLING · ENGRAVED · AT · LOADING

A solid bullet that loads easily even after many firings because of its unique cleaning action. Will not tumble. A perfect hunting bullet with heavy loads. Easy to cast. Shoots accurately even in greatly oversize barrels.

DOUBLE CAVITY WITH HANDLES 39.98

	Grains	Double
45 Cal.	200	90390
45 Cal.	250	90392
50 Cal.	250	90394
50 Cal.	320	90396
54 Cal.	300	90398
54 Cal.	380	90400
58 Cal.	440	90404



Combo Molds

45 CAL 200RB with Handles

90405 39.98

Double cavity mold casts one 45 Cal. 200 R-E-A-L bullet and one .440 diameter Round Ball.

50 CAL 320RB with Handles

90488 39.98

Double cavity mold casts one 50 Cal. 320 R-E-A-L bullet and one .490 diameter Round Ball.

RIFLING-ENGRAVED-AT-LOADING

The driving bands are large enough to adequately engage the rifling when pushed into the muzzle, and thin enough to easily engrave. They're strong enough to withstand maximum charges without stripping or gas cutting.

UNIQUE CLEANING ACTION You can shoot all day without cleaning your rifle between shots! When inserted into the muzzle, tiny scraping edges are swagged forward on each driving band. These perfect fitting scrapers remove the fouling from the previous shot.

EASIER, FASTER TO LOAD It's easy to load straight and true, easier and faster than a round ball with patch. Easily stabilized with very light

charges, the R-E-A-L bullet also retains accuracy with maximum loads. Each band is generously tapered to the rear with an angle close to that of a lathe center, so as to center the bullet against the rifle bands. When pushed in, the bullet automatically centers in the bore.

MORE ACCURATE The bevel base of the R-E-A-L bullet contributes to greater accuracy. When the bullet exits the bore, the gas escapes equally around the perimeter of the base. The uniform bevel is resistant to nicks that would permit gas to escape prematurely and cause a jet effect on one side of the bullet.



Conical Bullet Mold FOR BLACK POWDER REVOLVERS

A super accurate bullet that is easy to load straight and true. Two lube grooves prevent flash ignition and lead fouling. More energy and far greater accuracy than round balls.

39.98
DOUBLE

36 Cal. 375-130-1R	90378
44 Cal. Rem. 450-200-1R	90382
44 Ruger Old Army 456-220-1R	90384



WARNING Melting lead and casting lead objects will expose you and others in the area to lead, which is known to the State of California to cause reproductive harm and cancer. For more information, www.P65Warnings.ca.gov. See instructions on REDUCING EXPOSURE supplied with product.



LOAD SLUGS FOR LESS THAN STANDARD TRAPLOADS

Lee Slug Mold

Load slugs for less than standard trap loads. The Lee DRIVE KEY slug is loaded in standard trap hull with standard wad and conventional folded crimp. Slug loads are produced with any standard shot shell reloading press.

Lee Slug Mold features the exclusive drive key. The drive key positively rotates the slug in rifled shotgun barrels and doubles as a support rib allowing use of a standard trap wad—no need for a support wad or base filler. Sabot wad design outperforms rifled slugs in rifled slug barrels. Velocity and accuracy meet and exceed expensive factory loaded rifled slugs. Molds feature self centering automatic core pins for maximum speed and convenience. Mold is complete with sprue plate, handles and complete instructions with suggested loads.

Shotgun Slug Mold	1 oz.	12 ga.	90281	50.98
Shotgun Slug Mold	7/8 oz.	12 ga.	90282	50.98

EXCLUSIVE DRIVE KEY POSITIVELY ROTATES THE SLUG IN RIFLED BARRELS AND ELIMINATES THE NEED FOR SUPPORT WADS OR BASE FILLERS; ASSURES POSITIVE AND SMOOTH DISCARD OF THE SABOT WAD.



GUARANTEED MORE ACCURATE than factory slugs or your money back



WARNING Melting lead and casting lead objects will expose you and others in the area to lead, which is known to the State of California to cause reproductive harm and cancer. For more information, www.P65Warnings.ca.gov. See instructions on REDUCING EXPOSURE supplied with product.

18 CAVITY BUCKSHOT BULLET MOLDS



Lee 18 Cavity Buckshot Bullet Molds

Precision-machined molds produce 18 linked pellets per cast. Each cast produces enough pellets to load two 12 Gauge shotshells. Easily cast 3,000 pellets per hour. Handles shown not included. Order product No. 90005 on page 36.

Ball diameter .240 #4 BUCKSHOT	90028	75.00
Ball diameter .330 00 buckshot	90486	
Ball diameter .360 000 Buckshot	90192	
HANDLES	90005	26.98

LOAD SHOTGUN SHELLS, STEEL OR LEAD SHOT, TO LOOK AND SHOOT LIKE NEW

Lee Load-All II

Lee Load-All II shotgun shells not only look better than those loaded on machines costing hundreds of dollars, but they usually have more uniform velocity and patterns. You can load just as fast as with any other brand of loader costing up to \$200.

Twenty-four shot and powder bushings are included free. The bushings alone can cost several dollars each from other manufacturers— and they're not as accurate as those made by Lee. Only Lee supplies molded bushings.

This is a time proven tool. There are hundreds of thousands in use world wide: in nearly forty years, we have yet to see one worn out. Written two-year unconditional guarantee and a lifetime warranty.

Lee Load-All II	87.98
12 GAUGE	90011
16 GAUGE	90015
20 GAUGE	90012



Load-All Options

Conversion To Another Gauge

The Load-All II can be easily and economically converted to another gauge with the conversion kit. The entire die carrier is replaced so no adjustments are needed. The conversion kit includes the die carrier, steel sizer, wad guide, shell holder, load data and instructions.

CONVERSION KIT	28.98
12 GAUGE	90070
16 GAUGE	90071
20 GAUGE	90072

Lee Adjustable Shot Dipper

Accurately measure lead, bismuth and steel. Telescoping cup adjustable from 7/8 to 1 7/8 oz. Calibrated for lead shot. Works perfect for large pellet sizes. With steel, simply count out the pellets or weigh and set dipper accordingly.

90973 **3.98**



OUR PRODUCTION FACILITIES IN HARTFORD, WISCONSIN

Thank you for choosing
**LEE PRECISION
 PRODUCTS**

FROM THE CORNER of a one-car garage to nearly two acres under roof — for more than 63 years, the LEE family still continues to provide the best value in American made reloading equipment. Our family looks forward to another lifetime of supplying the best, most economical reloading equipment in the business. • JOHN LEE | PRESIDENT

The Lee Guarantee

LEE RELOADING PRODUCTS ARE GUARANTEED NOT TO WEAR OUT OR BREAK FROM NORMAL USE FOR TWO FULL YEARS OR THEY WILL BE REPAIRED OR REPLACED AT NO CHARGE, IF RETURNED TO THE FACTORY. ANY LEE PRODUCT OF CURRENT MANUFACTURE, REGARDLESS OF AGE OR CONDITION, WILL BE RECONDITIONED TO NEW, INCLUDING NEW GUARANTEE, IF RETURNED TO THE FACTORY WITH PAYMENT EQUAL TO HALF THE CURRENT RETAIL PRICE ⚡

AUTO BENCH PRIME | AUTO BREECH LOCK PRO | AUTO-DRUM | BREECH LOCK | CLASSIC CAST LOAD-MASTER | LEVER PRIME SYSTEM | LEE LOADER | LOAD-ALL II | RGB FACTORY CRIMP | PACESETTER | PERFECT POWDER MEASURE | SAFETY SCALE | AUTO-PRIME BULGE BUSTER | MICRO-BAND DRIVE KEY | R-E-A-L | ARE TRADEMARKS OF LEE PRECISION, INC.

www.leeprecision.com

LEE
 LEE PRECISION, INC.